

Switches and Sockets

Add a new dimension to your decor, with our award-winning ranges of modern switches and sockets. Combining world-class technical and safety features with stylish European and Australian design, we match form with function.



Overview	376
Quick reference	378
allure	382
finesse	390
silhouette	398
premiere	404
Mechanisms	413
Accessories	420
Weatherproof switches and sockets	422
Weatherproof isolators - IP66	423
Technical information	424

4 design styles, infinite combinations

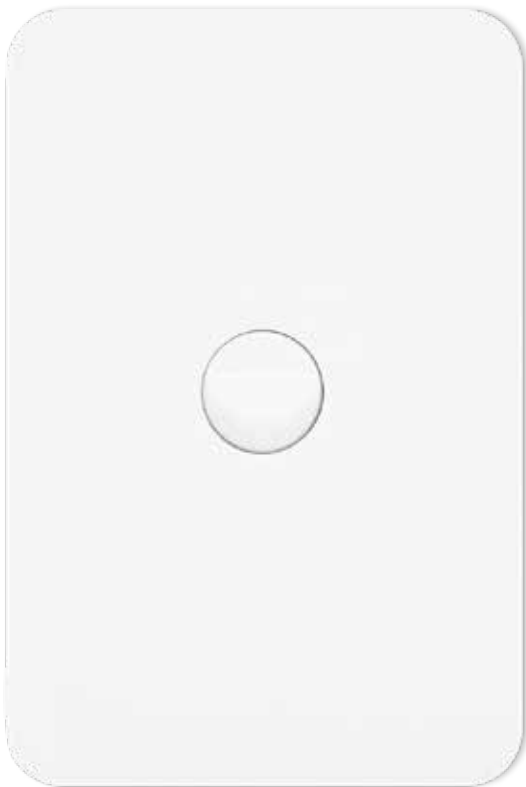

authentic, honest allure range

The allure range is a contemporary addition and evolution of our switches and sockets. We have refreshed the traditional contour with the vision of keeping it sustainable and classical. [Pg.382](#)

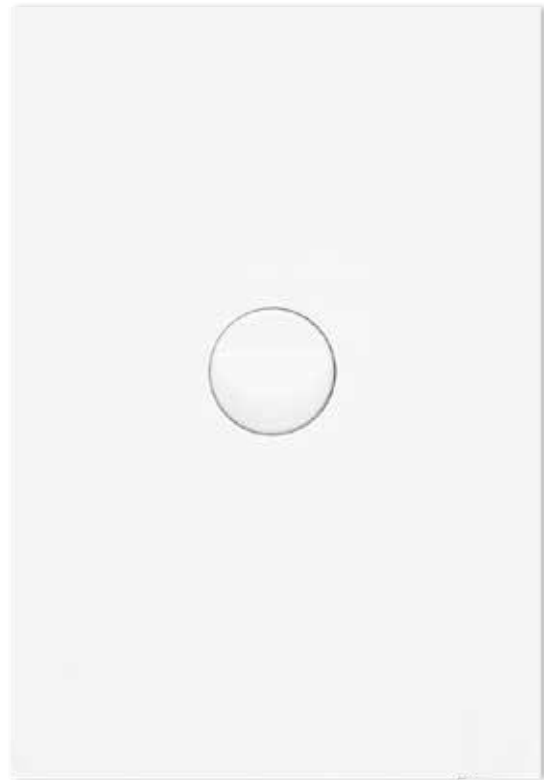

minimal, sleek finesse range

With the Hager design language in mind, the finesse range is an architectural story. Its timeless and slim design creates a world of small elegance, making the range peaceful and quiet. [Pg.390](#)



so fine, so stunning silhouette range

The silhouette range has a simple but elegant form based on the serene balance of proportions and the reduction to the object essentials, giving the product the right tone of voice in order to fit within its environment. [Pg.398](#)



A modern day classic premiere range

Quietly offering functionality and a beautifully understated form, premiere has a simple and stylish look that creates a soothing effect on its surroundings. [Pg.404](#)

Make the switch...



Extensive research with architects, interior designers, electrical contractors and consumers have created a dynamic, fully featured product range - with an array of styles, colours and finishes to suit any space.

Complete the picture Modules, Mechs and Accessories



Explore our wide range of modules, mechanisms and accessories to complete your installation and exceed your project requirements. [Pg.413](#)



allure

	Designation	Cat. Ref.	Pack QTY.	Page No.
Switch plates				
	1 gang large plate switch, no mechanism	WBHSP1	10	Page 384
	2 gang large plate switch, no mechanism	WBHSP2	10	
	3 gang large plate switch, no mechanism	WBHSP3	10	
	4 gang large plate switch, no mechanism	WBHSP4	10	
Switches				
	1 gang large plate vertical switch	WBHSV1	10	Page 386
	2 gang large plate vertical switch	WBHSV2	10	
	3 gang large plate vertical switch	WBHSV3	5	
	4 gang large plate vertical switch	WBHSV4	5	
Socket outlets				
	10A single horizontal socket	WBHP1	10	Page 388
	10A single vertical socket	WBHP1VS	10	
	10A double horizontal socket	WBHP2S	10	
	10A double horizontal socket with extra switch	WBHP2XS	5	

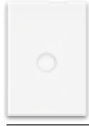
finesse

	Designation	Cat. Ref.	Pack QTY.	Page No.
Switch plates				
	1 gang large plate switch, no mechanism	WBQSP1	10	Page 392
	2 gang large plate switch, no mechanism	WBQSP2	10	
	3 gang large plate switch, no mechanism	WBQSP3	10	
	4 gang large plate switch, no mechanism	WBQSP4	10	
Switches				
	1 gang large plate vertical switch	WBQSV1	10	Page 393
	2 gang large plate vertical switch	WBQSV2	10	
	3 gang large plate vertical switch	WBQSV3	5	
	4 gang large plate vertical switch	WBQSV4	5	
Mechanical Push Button Switches				
	1 gang large plate vertical mechanical push button switch	WBQSV1PB	10	Page 393
	2 gang large plate vertical mechanical push button switch	WBQSV2PB	10	
	3 gang large plate vertical mechanical push button switch	WBQSV3PB	5	
	4 gang large plate vertical mechanical push button switch	WBQSV4PB	5	
Socket outlets				
	10A single horizontal socket	WBQP1S	10	Page 395
	10A single vertical socket	WBQP1VS	10	
	10A double horizontal socket	WBQP2S	10	
	10A double horizontal socket with extra switch	WBQP2XS	5	

silhouette

Switch plates



Designation	Cat. Ref.	Pack QTY.	Page No.
1 gang large plate switch, no mechanism	WBSSP1	10	
2 gang large plate switch, no mechanism	WBSSP2	10	Page 400
3 gang large plate switch, no mechanism	WBSSP3	10	
4 gang large plate switch, no mechanism	WBSSP4	10	

Switches



1 gang large plate vertical switch	WBSSV1	10	
2 gang large plate vertical switch	WBSSV2	10	Page 400
3 gang large plate vertical switch	WBSSV3	5	
4 gang large plate vertical switch	WBSSV4	5	

Electronic push button switches



1 gang large plate vertical electronic push button switch	WBSEV1	1	
2 gang large plate vertical electronic push button switch	WBSEV2	1	Page 400/401
3 gang large plate vertical electronic push button switch	WBSEV3	1	
4 gang large plate vertical electronic push button switch	WBSEV4	1	

Socket outlets



10A single horizontal socket	WBSP1S	10	
10A single vertical socket	WBSP1VS	10	Page 401
10A double horizontal socket	WBSP2S	10	
10A double horizontal socket with extra switch	WBSP2XS	5	

premiere

Switch plates



Designation	Cat. Ref.	Pack QTY.	Page No.
1 gang large plate switch, no mechanism	WBSP1	10	
2 gang large plate switch, no mechanism	WBSP2	10	Page 406
3 gang large plate switch, no mechanism	WBSP3	10	
4 gang large plate switch, no mechanism	WBSP4	10	

Switches



1 gang large plate vertical switch	WBSV1	10	
2 gang large plate vertical switch	WBSV2	10	Page 407
3 gang large plate vertical switch	WBSV3	5	
4 gang large plate vertical switch	WBSV4	5	



Socket outlets





10A single horizontal socket	WBP1S	1	
10A double horizontal socket	WBP2S	1	
10A double horizontal socket with extra switch	WBP2XS	1	Page 410
10A single vertical socket	WBP1VS	10	
10A twin vertical socket	WBP2VS	10	

Mechanisms

Standard and printed

	Designation	Cat. Ref.	Pack QTY.	Page No.
	Electronic Push Button	WBME5A	5	Page 414
	Universal Electronic Push Button Dimmer	WBMDUPB	5	
	Universal Rotary on/off Dimmer	WBMDUR	5	
	Slave	WBMSLL	5	
	16AX rated mechanism	WBM16AX	10	Page 415
	10A intermediate mechanism	WBM10I	5	
	10A double pole mechanism	WBM10D	5	
	10A 3 position rotary mechanism	WBM10R3	5	
<h4>Data and television</h4> 	Cat 6 jack	WBMCAT6	10	Page 418
	F to PAL mechanism	WBMTV75PF	10	
	F to F 'Foxtel' approved	WBMTV75PY	10	

Accessories

	Designation	Cat. Ref.	Pack QTY.	Page No.
Mounting and surface accessories				
	Mounting block 32mm deep - suits Premiere range	WBBMD	5	Page 420
	Mounting block 32mm deep - insulated - suits Premiere range	WBBMI	5	
	Mounting block 32mm deep - suits silhouette range	WBSBMD	5	
	Mounting block 32mm deep - suits Allure range	WBHBMD	5	
	Mounting block 32mm deep - suits Finesse range	WBQBMD	5	
	10A single surface socket	WBAP1	10	
	Giant junction box	WBAJB4	5	Page 421
	Standard junction box	WBAJB4S	5	

allure

authentic, honest



Continuing on with Hager's design philosophy, the allure range is serenely balanced and can elevate any modern interior with its simplistic yet contemporary design.

The translucent edge that surrounds allure, accentuates its elegant profile – creating a unique floating effect.



Advantages:

- Available in gloss white, matt white and matt black to suit any decor or mood
- Quick close IP2x hinged screw caps
- Pre-fitted mounting screws for a quick installation
- Rotoloc® system

Characteristics:

- | | |
|-----------------------|---------------------------------|
| - External material: | - UV stabilised |
| - Switches terminals: | - 4 x 1.5mm ² cables |
| - Sockets terminals: | - 4 x 2.5mm ² cables |



01

Architecturally designed in Europe.



02

Available in Matt White, Matt Black and Gloss White.



03

Strong impact resistant polycarbonate material will not 'yellow' over time.



04

Our patented Rotoloc® system eliminates the possibility of the mechanism being pushed back into the wall cavity.



05

Easy hinged. IP2x, caps and screws ready to go.



06

A spring loaded shutter protects little fingers from live parts inside sockets.



07

A full range of accessories and mechs including electronic push buttons and dimmers are available.



08

Built in spirit level to assist installation.

Features

- Multiple mounting holes
- Supplied with standard 32mm fixing screws
- No mechanism push back
- High impact, high gloss UV stabilised polycarbonate construction
- Spray matt finishes available in matt white and matt black
- Level to assist installation
- Hinged IP2x caps
- Screw retention



WBHSP1

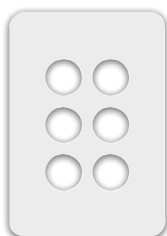

WBHSP6

Switch Plates - No Mechanisms

Description	Available colours	Box qty	Cat ref.
1 gang	<input type="radio"/> Gloss White	10	★ WBHSP1
	<input checked="" type="radio"/> Matt Black	10	★ WBHSP1-MB
	<input type="radio"/> Matt White	10	★ WBHSP1-MW
2 gang	<input type="radio"/> Gloss White	10	★ WBHSP2
	<input checked="" type="radio"/> Matt Black	10	★ WBHSP2-MB
	<input type="radio"/> Matt White	10	★ WBHSP2-MW
3 gang	<input type="radio"/> Gloss White	10	★ WBHSP3
	<input checked="" type="radio"/> Matt Black	10	★ WBHSP3-MB
	<input type="radio"/> Matt White	10	★ WBHSP3-MW
4 gang	<input type="radio"/> Gloss White	10	★ WBHSP4
	<input checked="" type="radio"/> Matt Black	10	★ WBHSP4-MB
	<input type="radio"/> Matt White	10	★ WBHSP4-MW
5 gang	<input type="radio"/> Gloss White	10	★ WBHSP5
	<input checked="" type="radio"/> Matt Black	10	★ WBHSP5-MB
	<input type="radio"/> Matt White	10	★ WBHSP5-MW
6 gang	<input type="radio"/> Gloss White	10	★ WBHSP6
	<input checked="" type="radio"/> Matt Black	10	★ WBHSP6-MB
	<input type="radio"/> Matt White	10	★ WBHSP6-MW
Blank	<input type="radio"/> Gloss White	10	★ WBHSPB
	<input checked="" type="radio"/> Matt Black	10	★ WBHSPB-MB
	<input type="radio"/> Matt White	10	★ WBHSPB-MW
Cable entry	<input type="radio"/> Gloss White	10	★ WBHSPCE
	<input checked="" type="radio"/> Matt Black	10	★ WBHSPCE-MB
	<input type="radio"/> Matt White	10	★ WBHSPCE-MW

Features

- Multiple mounting holes
- Supplied with standard 32mm fixing screws
- High impact, high gloss UV stabilised polycarbonate construction
- For use with non-Hager mechanisms
- Spray matt finishes available in matt white and matt black
- Level to assist installation
- Hinged IP2x caps
- Screw retention

Switch Plates - Hybrid

Description	Available colours	Box qty	Cat ref.
1 gang	<input type="radio"/> Gloss White	10	★ WBHHSP1
	<input checked="" type="radio"/> Matt Black	10	★ WBHHSP1-MB
	<input type="radio"/> Matt White	10	★ WBHHSP1-MW
2 gang	<input type="radio"/> Gloss White	10	★ WBHHSP2
	<input checked="" type="radio"/> Matt Black	10	★ WBHHSP2-MB
	<input type="radio"/> Matt White	10	★ WBHHSP2-MW
3 gang	<input type="radio"/> Gloss White	10	★ WBHHSP3
	<input checked="" type="radio"/> Matt Black	10	★ WBHHSP3-MB
	<input type="radio"/> Matt White	10	★ WBHHSP3-MW
4 gang	<input type="radio"/> Gloss White	10	★ WBHHSP4
	<input checked="" type="radio"/> Matt Black	10	★ WBHHSP4-MB
	<input type="radio"/> Matt White	10	★ WBHHSP4-MW

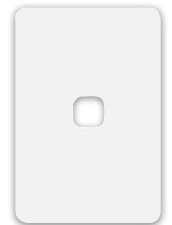

WBHHSP1

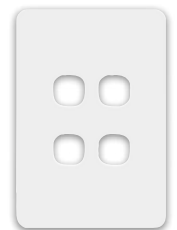

WBHHSP4

Features

- Multiple mounting holes
- Supplied with captive 32mm fixing screws
- No mechanism push back
- High impact, high gloss UV stabilised polycarbonate construction
- Level to assist installation
- Spray matt finishes available in matt white and matt black
- Switch when supplied are fitted with 16AX mechanisms (suitable for fluorescent loads)
- 2 way and loop terminal as standard
- Hinged IP2x caps
- Combination head screws Phillip's #1 'backed off' for ease of cable insertion
- Terminals accommodate 4 x 1.5mm² cable

Dimension data: [Page 426 and 427](#)



WBHSV1



WBHSV1-MB

Switches

Description	Available colours	Box qty	Cat ref.
1 gang	<input type="radio"/> Gloss White	10	★ WBHSV1
	<input checked="" type="radio"/> Matt Black	10	★ WBHSV1-MB
	<input type="radio"/> Matt White	10	★ WBHSV1-MW
2 gang	<input type="radio"/> Gloss White	10	★ WBHSV2
	<input checked="" type="radio"/> Matt Black	10	★ WBHSV2-MB
	<input type="radio"/> Matt White	10	★ WBHSV2-MW
3 gang	<input type="radio"/> Gloss White	5	★ WBHSV3
	<input checked="" type="radio"/> Matt Black	5	★ WBHSV3-MB
	<input type="radio"/> Matt White	5	★ WBHSV3-MW
4 gang	<input type="radio"/> Gloss White	5	★ WBHSV4
	<input checked="" type="radio"/> Matt Black	5	★ WBHSV4-MB
	<input type="radio"/> Matt White	5	★ WBHSV4-MW
5 gang	<input type="radio"/> Gloss White	5	★ WBHSV5
	<input checked="" type="radio"/> Matt Black	5	★ WBHSV5-MB
	<input type="radio"/> Matt White	5	★ WBHSV5-MW
6 gang	<input type="radio"/> Gloss White	5	★ WBHSV6
	<input checked="" type="radio"/> Matt Black	5	★ WBHSV6-MB
	<input type="radio"/> Matt White	5	★ WBHSV6-MW

Switches - Architrave

Description	Available colours	Box qty	Cat ref.
1 gang	<input type="radio"/> Gloss White	5	★ WBHSA1
	<input checked="" type="radio"/> Matt Black	5	★ WBHSA1-MB
	<input type="radio"/> Matt White	5	★ WBHSA1-MW
2 gang	<input type="radio"/> Gloss White	5	★ WBHSA2
	<input checked="" type="radio"/> Matt Black	5	★ WBHSA2-MB
	<input type="radio"/> Matt White	5	★ WBHSA2-MW
3 gang	<input type="radio"/> Gloss White	5	★ WBHSA3
	<input checked="" type="radio"/> Matt Black	5	★ WBHSA3-MB
	<input type="radio"/> Matt White	5	★ WBHSA3-MW



WBHSA2

Features

- Multiple mounting holes
- Supplied with captive 32mm tapered point fixing screws
- No mechanism push back
- High impact, high gloss UV stabilised polycarbonate construction
- Level to assist installation
- Spray matt finishes available in matt white and matt black
- 2 way and loop terminal as standard
- Combination head screws Phillip's #1 'backed off' for ease of cable insertion
- Hinged IP2x caps
- Terminals accommodate 4 x 1.5mm² cable

Cooker switch features

- Double pole
- Comes with 2 covers
 - One marked with 'cooker'
 - One with no marking
- Terminals accept 6mm² cable

Dimension data: [Page 426 and 427](#)



IP44 Switches - vertical

Description	Characteristics	Available colours	Box qty	Cat ref.
1 gang	10A	<input type="radio"/> Gloss White	10	★ WBHWSV1
		<input checked="" type="radio"/> Matt Black	10	★ WBHWSV1-MB
		<input type="radio"/> Matt White	10	★ WBHWSV1-MW
2 gang	10A	<input type="radio"/> Gloss White	10	★ WBHWSV2
		<input checked="" type="radio"/> Matt Black	10	★ WBHWSV2-MB
		<input type="radio"/> Matt White	10	★ WBHWSV2-MW
3 gang	10A	<input type="radio"/> Gloss White	10	★ WBHWSV3
		<input checked="" type="radio"/> Matt Black	10	★ WBHWSV3-MB
		<input type="radio"/> Matt White	10	★ WBHWSV3-MW



WBHWSV1

IP44 Switches - horizontal

Description	Characteristics	Available colours	Box qty	Cat ref.
1 gang	10A	<input type="radio"/> Gloss White	10	★ WBHWSH1
		<input checked="" type="radio"/> Matt Black	10	★ WBHWSH1-MB
		<input type="radio"/> Matt White	10	★ WBHWSH1-MW
2 gang	10A	<input type="radio"/> Gloss White	10	★ WBHWSH2
		<input checked="" type="radio"/> Matt Black	10	★ WBHWSH2-MB
		<input type="radio"/> Matt White	10	★ WBHWSH2-MW
3 gang	10A	<input type="radio"/> Gloss White	10	★ WBHWSH3
		<input checked="" type="radio"/> Matt Black	10	★ WBHWSH3-MB
		<input type="radio"/> Matt White	10	★ WBHWSH3-MW

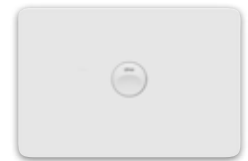

WBHWSH1

Switches - Cooker Switch

Description	Characteristics	Available colours	Box qty	Cat ref.
Horizontal cooker switch Double pole	40A	<input type="radio"/> Gloss White	1	★ WBHCKSH1
		<input checked="" type="radio"/> Matt Black	1	★ WBHCKSH1-MB
		<input type="radio"/> Matt White	1	★ WBHCKSH1-MW
Vertical cooker switch Double pole	40A	<input type="radio"/> Gloss White	1	★ WBHCKSV1
		<input checked="" type="radio"/> Matt Black	1	★ WBHCKSV1-MB
		<input type="radio"/> Matt White	1	★ WBHCKSV1-MW



WBHCKSV1

Switches and sockets

Features

- Removable covers for ease of painting
- Multiple mounting holes
- Terminal screws "backed off"
- Level to assist installation
- Bevelled and colour coded cable entries aligned for ease of termination
- Supplied with retained tapered point 32mm fixing screws
- Hinged IP2x caps
- Spray matt finishes available in matt white and matt black

Technical data

- All sockets 250V 50Hz rated
- Extra switch models fitted with 16AX mechanisms
- High impact, high gloss UV stabilised polycarbonate construction
- Terminal accommodates 4 x 2.5mm² cable

Dimension data: [Page 426](#)



WBHP2S



WBHP2S-MB



WBHP2SUSBAC-MW

Sockets - horizontal

Description	Characteristics	Available colours	Box qty	Cat ref.
Single sockets	10A	<input type="radio"/> Gloss White	10	★ WBHP1S
		<input type="radio"/> Matt Black	10	★ WBHP1S-MB
		<input type="radio"/> Matt White	10	★ WBHP1S-MW
	10A 'Round Earth'	<input type="radio"/> Gloss White	10	★ WBHP1R
		<input type="radio"/> Matt Black	10	★ WBHP1R-MB
		<input type="radio"/> Matt White	10	★ WBHP1R-MW
	15A	<input type="radio"/> Gloss White	5	★ WBHP115
		<input type="radio"/> Matt Black	5	★ WBHP115-MB
		<input type="radio"/> Matt White	5	★ WBHP115-MW
20A	<input type="radio"/> Gloss White	5	★ WBHP120	
	<input type="radio"/> Matt Black	5	★ WBHP120-MB	
	<input type="radio"/> Matt White	5	★ WBHP120-MW	
Double sockets	10A	<input type="radio"/> Gloss White	10	★ WBHP2S
		<input type="radio"/> Matt Black	10	★ WBHP2S-MB
		<input type="radio"/> Matt White	10	★ WBHP2S-MW
		Double sockets with extra 16AX switch	10A	<input type="radio"/> Gloss White
		<input type="radio"/> Matt Black	5	★ WBHP2XS-MB
		<input type="radio"/> Matt White	5	★ WBHP2XS-MW
		Double sockets with extra switch position (no mech)	10A	<input type="radio"/> Gloss White
		<input type="radio"/> Matt Black	1	★ WBHP2XSB-MB
		<input type="radio"/> Matt White	1	★ WBHP2XSB-MW
		Double sockets with USB Type A and Type C	10A	<input type="radio"/> Gloss White
		<input type="radio"/> Matt Black	5	★ WBHP2SUSBAC-MB
		<input type="radio"/> Matt White	5	★ WBHP2SUSBAC-MW

Sockets - vertical

Description	Characteristics	Available colours	Box qty	Cat ref.
		<input type="radio"/> Gloss White	10	★ WBHP1V
		<input type="radio"/> Matt Black	10	★ WBHP1V-MB
		<input type="radio"/> Matt White	10	★ WBHP1V-MW



WBHP1V-MB

4 Gang Socket Cover Kit

Description	Characteristics	Available colours	Box qty	Cat ref.
		<input type="radio"/> Gloss White	5	★ WBHA4PP
		<input type="radio"/> Matt Black	5	★ WBHA4PP-MB
		<input type="radio"/> Matt White	5	★ WBHA4PP-MW

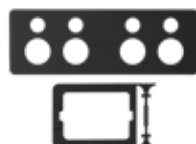

WBHA4PP-MB

Note: 2x allure double sockets (WBHP2S-xx) required (not supplied with kit)

Features

- High impact, high gloss UV stabilised polycarbonate
- Spray matt finishes available in matt white and matt black

Switch Cover Plates

Description	Available colours	Box qty	Cat ref.
1 gang	<input type="radio"/> Gloss White	10	★ WBHCS1
	<input checked="" type="radio"/> Matt Black	10	★ WBHCS1-MB
	<input type="radio"/> Matt White	10	★ WBHCS1-MW
2 gang	<input type="radio"/> Gloss White	10	★ WBHCS2
	<input checked="" type="radio"/> Matt Black	10	★ WBHCS2-MB
	<input type="radio"/> Matt White	10	★ WBHCS2-MW
3 gang	<input type="radio"/> Gloss White	10	★ WBHCS3
	<input checked="" type="radio"/> Matt Black	10	★ WBHCS3-MB
	<input type="radio"/> Matt White	10	★ WBHCS3-MW
4 gang	<input type="radio"/> Gloss White	10	★ WBHCS4
	<input checked="" type="radio"/> Matt Black	10	★ WBHCS4-MB
	<input type="radio"/> Matt White	10	★ WBHCS4-MW
5 gang	<input type="radio"/> Gloss White	10	★ WBHCS5
	<input checked="" type="radio"/> Matt Black	10	★ WBHCS5-MB
	<input type="radio"/> Matt White	10	★ WBHCS5-MW
6 gang	<input type="radio"/> Gloss White	10	★ WBHCS6
	<input checked="" type="radio"/> Matt Black	10	★ WBHCS6-MB
	<input type="radio"/> Matt White	10	★ WBHCS6-MW

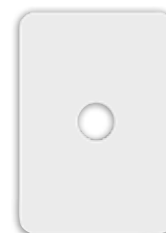

WBHCS1

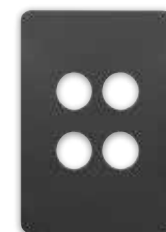

WBHCS4-MB

Socket Cover Plates - horizontal

Description	Available colours	Box qty	Cat ref.
Cover single socket	<input type="radio"/> Gloss White	5	★ WBHCP1
	<input checked="" type="radio"/> Matt Black	5	★ WBHCP1-MB
	<input type="radio"/> Matt White	5	★ WBHCP1-MW
Cover double socket	<input type="radio"/> Gloss White	5	★ WBHCP2
	<input checked="" type="radio"/> Matt Black	5	★ WBHCP2-MB
	<input type="radio"/> Matt White	5	★ WBHCP2-MW
Cover double socket with extra switch	<input type="radio"/> Gloss White	5	★ WBHCP2XS
	<input checked="" type="radio"/> Matt Black	5	★ WBHCP2XS-MB
	<input type="radio"/> Matt White	5	★ WBHCP2XS-MW

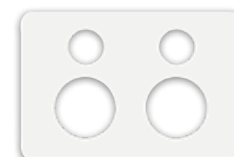

WBHCP2-MW

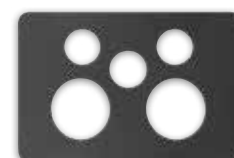

WBHCP2XS-MB

Switches and sockets

Socket Cover Plates - vertical

Description	Available colours	Box qty	Cat ref.
Cover single socket	<input type="radio"/> Gloss White	5	★ WBHCP1V
	<input checked="" type="radio"/> Matt Black	5	★ WBHCP1V-MB
	<input type="radio"/> Matt White	5	★ WBHCP1V-MW



WBHCP1V-MB

finesse

minimal, sleek



The architecturally inspired finesse range is sure to impress audiences with its minimalistic and precise design, and is considered to be ingeniously simplistic.

Its remarkable slim profile together with a refined translucent edge, perfectly complements the sharp and clean lines of a surrounding modern interior.



Advantages:

- Sleek 4.6mm profile
- Available in gloss white, matt white and matt black to suit any decor or mood
- Rotoloc® system

Characteristics:

- | | |
|-----------------------|---------------------------------|
| - External material: | - UV stabilised |
| - Switches terminals: | - 4 x 1.5mm ² cables |
| - Sockets terminals: | - 4 x 2.5mm ² cables |



01

With a profile of only 4.6mm off the wall surface, finesse has the lowest profile on the market.



02

Terminal screws partially backed out for faster installation.



03

Strong impact and UV resistant polycarbonate material will not 'yellow' over time.



04

Our patented Rotoloc® system eliminates the possibility of the mechanism being pushed back into the wall cavity.



05

Deep screw housing provides a cap free installation that meets standards compliance.



06

A spring loaded shutter protects little fingers from live parts inside sockets.



07

Available in Matt Black, Matt White and Gloss White.



08

A full range of accessories and mechs including mechanical or electronic push button switches and universal dimmers.

Features

- Multiple mounting holes
- Supplied with standard 32mm tapered point fixing screws
- No mechanism push back
- High impact, high gloss UV stabilised polycarbonate construction
- Spray matt finishes available in matt white and matt black
- Screw retention
- Hybrid plates for non-Hager Roto-loc mechanisms



WBQSP4

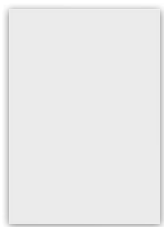

WBQSPB

Switch Plates - No Mechanisms

Description	Available colours	Box qty	Cat ref.
1 gang	<input type="radio"/> Gloss White	10	★ WBQSP1
	<input checked="" type="radio"/> Matt Black	10	★ WBQSP1-MB
	<input type="radio"/> Matt White	10	★ WBQSP1-MW
2 gang	<input type="radio"/> Gloss White	10	★ WBQSP2
	<input checked="" type="radio"/> Matt Black	10	★ WBQSP2-MB
	<input type="radio"/> Matt White	10	★ WBQSP2-MW
3 gang	<input type="radio"/> Gloss White	10	★ WBQSP3
	<input checked="" type="radio"/> Matt Black	10	★ WBQSP3-MB
	<input type="radio"/> Matt White	10	★ WBQSP3-MW
4 gang	<input type="radio"/> Gloss White	10	★ WBQSP4
	<input checked="" type="radio"/> Matt Black	10	★ WBQSP4-MB
	<input type="radio"/> Matt White	10	★ WBQSP4-MW
5 gang	<input type="radio"/> Gloss White	10	★ WBQSP5
	<input checked="" type="radio"/> Matt Black	10	★ WBQSP5-MB
	<input type="radio"/> Matt White	10	★ WBQSP5-MW
6 gang	<input type="radio"/> Gloss White	10	★ WBQSP6
	<input checked="" type="radio"/> Matt Black	10	★ WBQSP6-MB
	<input type="radio"/> Matt White	10	★ WBQSP6-MW
Blank	<input type="radio"/> Gloss White	10	★ WBQSPB
	<input checked="" type="radio"/> Matt Black	10	★ WBQSPB-MB
	<input type="radio"/> Matt White	10	★ WBQSPB-MW
Brush cable entry plate	<input type="radio"/> Gloss White	10	★ WBQSPCE
	<input checked="" type="radio"/> Matt Black	10	★ WBQSPCE-MB
	<input type="radio"/> Matt White	10	★ WBQSPCE-MW



WBQHSP1



WBQHSP4

Switch Plates - Hybrid

(For use with non-Hager mechanisms)

Description	Available colours	Box qty	Cat ref.
1 gang	<input type="radio"/> Gloss White	10	★ WBQHSP1
	<input checked="" type="radio"/> Matt Black	10	★ WBQHSP1-MB
	<input type="radio"/> Matt White	10	★ WBQHSP1-MW
2 gang	<input type="radio"/> Gloss White	10	★ WBQHSP2
	<input checked="" type="radio"/> Matt Black	10	★ WBQHSP2-MB
	<input type="radio"/> Matt White	10	★ WBQHSP2-MW
3 gang	<input type="radio"/> Gloss White	10	★ WBQHSP3
	<input checked="" type="radio"/> Matt Black	10	★ WBQHSP3-MB
	<input type="radio"/> Matt White	10	★ WBQHSP3-MW
4 gang	<input type="radio"/> Gloss White	10	★ WBQHSP4
	<input checked="" type="radio"/> Matt Black	10	★ WBQHSP4-MB
	<input type="radio"/> Matt White	10	★ WBQHSP4-MW

Features

- Multiple mounting holes
- Supplied with captive 32mm tapered point fixing screws
- No mechanism push back
- High impact, high gloss UV stabilised polycarbonate construction
- Press mechs 10A
- Spray matt finishes available in matt white and matt black
- Switch when supplied are fitted with 16AX mechanisms (suitable for fluorescent loads)
- 2 way and loop terminal as standard
- Combination head screws 'backed off' for ease of cable insertion
- Terminals accommodate 4 x 1.5mm² cable
- Push button mechanical switches rated 10A
- 240V press button mechs - 10AX

Dimension data: [Page 428](#)



Switches

Description	Available colours	Box qty	Cat ref.
1 gang	<input type="radio"/> Gloss White	10	★ WBQSV1
	<input checked="" type="radio"/> Matt Black	10	★ WBQSV1-MB
	<input type="radio"/> Matt White	10	★ WBQSV1-MW
2 gang	<input type="radio"/> Gloss White	10	★ WBQSV2
	<input checked="" type="radio"/> Matt Black	10	★ WBQSV2-MB
	<input type="radio"/> Matt White	10	★ WBQSV2-MW
3 gang	<input type="radio"/> Gloss White	5	★ WBQSV3
	<input checked="" type="radio"/> Matt Black	5	★ WBQSV3-MB
	<input type="radio"/> Matt White	5	★ WBQSV3-MW
4 gang	<input type="radio"/> Gloss White	5	★ WBQSV4
	<input checked="" type="radio"/> Matt Black	5	★ WBQSV4-MB
	<input type="radio"/> Matt White	5	★ WBQSV4-MW
5 gang	<input type="radio"/> Gloss White	5	★ WBQSV5
	<input checked="" type="radio"/> Matt Black	5	★ WBQSV5-MB
	<input type="radio"/> Matt White	5	★ WBQSV5-MW
6 gang	<input type="radio"/> Gloss White	5	★ WBQSV6
	<input checked="" type="radio"/> Matt Black	5	★ WBQSV6-MB
	<input type="radio"/> Matt White	5	★ WBQSV6-MW



WBQSV1



WBQSV4-MB

Switches with 240V Press Mech

Description	Characteristics	Available colours	Box qty	Cat ref.
1 gang	10A	<input type="radio"/> Gloss White	10	★ WBQSV1PB
		<input checked="" type="radio"/> Matt Black	10	★ WBQSV1PB-MB
		<input type="radio"/> Matt White	10	★ WBQSV1PB-MW
2 gang	10A	<input type="radio"/> Gloss White	10	★ WBQSV2PB
		<input checked="" type="radio"/> Matt Black	10	★ WBQSV2PB-MB
		<input type="radio"/> Matt White	10	★ WBQSV2PB-MW
3 gang	10A	<input type="radio"/> Gloss White	5	★ WBQSV3PB
		<input checked="" type="radio"/> Matt Black	5	★ WBQSV3PB-MB
		<input type="radio"/> Matt White	5	★ WBQSV3PB-MW
4 gang	10A	<input type="radio"/> Gloss White	5	★ WBQSV4PB
		<input checked="" type="radio"/> Matt Black	5	★ WBQSV4PB-MB
		<input type="radio"/> Matt White	5	★ WBQSV4PB-MW
240V LED for PB mech LED - blue (Not supplied with switches)	240V		20	★ WBAPBLED



WBQSV1PB

Features

- Multiple mounting holes
 - Supplied with captive 32mm tapered point fixing screws
 - No mechanism push back
 - High impact, high gloss UV stabilised polycarbonate construction
 - Spray matt finishes available in matt white and matt black
 - Switch when supplied are fitted with 16AX mechanisms (suitable for fluorescent loads)
- 2 way and loop terminal as standard
 - Terminals accommodate 4 x 1.5mm² cable
 - Combination head screws Phillip's #1 'backed off' for ease of cable insertion

Cooker switch features

- Double pole
- Comes with 2 covers
- One marked with 'cooker'
- One with no marking
- Terminals accept 6mm² cable

Dimension data: [Page 428 and 429](#)



WBQSA2

Architrave Switches

Description	Available colours	Box qty	Cat ref.
1 gang	○ Gloss White	10	★ WBQSA1
	● Matt Black	10	★ WBQSA1-MB
	○ Matt White	10	★ WBQSA1-MW
2 gang	○ Gloss White	10	★ WBQSA2
	● Matt Black	10	★ WBQSA2-MB
	○ Matt White	10	★ WBQSA2-MW
3 gang	○ Gloss White	5	★ WBQSA3
	● Matt Black	5	★ WBQSA3-MB
	○ Matt White	5	★ WBQSA3-MW



WBQCKSV1

Switches - Cooker Switch

Description	Characteristics	Available colours	Box qty	Cat ref.
Vertical cooker switch Double pole	40A	○ Gloss White	5	★ WBQCKSV1
		● Matt Black	5	★ WBQCKSV1-MB
		○ Matt White	5	★ WBQCKSV1-MW
Horizontal cooker switch Double pole	40A	○ Gloss White	5	★ WBQCKSH1
		● Matt Black	5	★ WBQCKSH1-MB
		○ Matt White	5	★ WBQCKSH1-MW

Features

- Removable covers for ease of painting
- Multiple mounting holes
- Terminal screws "backed off"
- Bevelled and colour coded cable entries aligned for ease of termination
- Supplied with retained tapered point 32mm fixing screws
- Spray matt finishes available in matt white and matt black

Technical data

- All sockets 250V 50Hz rated
- Extra switch models fitted with 16AX mechanisms
- Terminal accommodates 4 x 2.5mm² cable
- High impact, high gloss UV stabilised polycarbonate construction

Dimension data: [Page 428](#)



Sockets - horizontal

Description	Characteristics	Available colours	Box qty	Cat ref.
Single sockets	10A	<input type="radio"/> Gloss White	10	★ WBQP1S
		<input checked="" type="radio"/> Matt Black	10	★ WBQP1S-MB
		<input type="radio"/> Matt White	10	★ WBQP1S-MW
	10A 'Round Earth'	<input type="radio"/> Gloss White	10	★ WBQP1R
		<input checked="" type="radio"/> Matt Black	10	★ WBQP1R-MB
		<input type="radio"/> Matt White	10	★ WBQP1R-MW
	15A	<input type="radio"/> Gloss White	5	★ WBQP115S
		<input checked="" type="radio"/> Matt Black	5	★ WBQP115S-MB
		<input type="radio"/> Matt White	5	★ WBQP115S-MW
Double sockets	10A	<input type="radio"/> Gloss White	10	★ WBQP2S
		<input checked="" type="radio"/> Matt Black	10	★ WBQP2S-MB
		<input type="radio"/> Matt White	10	★ WBQP2S-MW
Double sockets with extra switch	10A	<input type="radio"/> Gloss White	5	★ WBQP2XS
		<input checked="" type="radio"/> Matt Black	5	★ WBQP2XS-MB
		<input type="radio"/> Matt White	5	★ WBQP2XS-MW
Double sockets blanked extra switch	10A	<input type="radio"/> Gloss White	1	★ WBQP2XSB
		<input checked="" type="radio"/> Matt Black	1	★ WBQP2XSB-MB
		<input type="radio"/> Matt White	1	★ WBQP2XSB-MW
Double sockets with USB Type A and Type C	10A	<input type="radio"/> Gloss White	5	★ WBQP2SUSBAC
		<input checked="" type="radio"/> Matt Black	5	★ WBQP2SUSBAC-MB
		<input type="radio"/> Matt White	5	★ WBQP2SUSBAC-MW



WBQP2S



WBQP2S-MB



WBQP2XS

Sockets - vertical

Description	Characteristics	Available colours	Box qty	Cat ref.
Single socket	10A	<input type="radio"/> Gloss White	10	★ WBQP1VS
		<input checked="" type="radio"/> Matt Black	10	★ WBQP1VS-MB
		<input type="radio"/> Matt White	10	★ WBQP1VS-MW



WBQP1VS

Features

- High impact, high gloss UV stabilised polycarbonate
- Spray matt finishes available in matt white and matt black



WBQCV1



WBQCV4

Switch Cover Plates

Description	Available colours	Box qty	Cat ref.
1 gang	<input type="radio"/> Gloss White	10	★ WBQCV1
	<input checked="" type="radio"/> Matt Black	10	★ WBQCV1-MB
	<input type="radio"/> Matt White	10	★ WBQCV1-MW
2 gang	<input type="radio"/> Gloss White	10	★ WBQCV2
	<input checked="" type="radio"/> Matt Black	10	★ WBQCV2-MB
	<input type="radio"/> Matt White	10	★ WBQCV2-MW
3 gang	<input type="radio"/> Gloss White	10	★ WBQCV3
	<input checked="" type="radio"/> Matt Black	10	★ WBQCV3-MB
	<input type="radio"/> Matt White	10	★ WBQCV3-MW
4 gang	<input type="radio"/> Gloss White	10	★ WBQCV4
	<input checked="" type="radio"/> Matt Black	10	★ WBQCV4-MB
	<input type="radio"/> Matt White	10	★ WBQCV4-MW
5 gang	<input type="radio"/> Gloss White	10	★ WBQCV5
	<input checked="" type="radio"/> Matt Black	10	★ WBQCV5-MB
	<input type="radio"/> Matt White	10	★ WBQCV5-MW
6 gang	<input type="radio"/> Gloss White	10	★ WBQCV6
	<input checked="" type="radio"/> Matt Black	10	★ WBQCV6-MB
	<input type="radio"/> Matt White	10	★ WBQCV6-MW

Features

- High impact, high gloss UV stabilised polycarbonate
- Spray matt finishes available in matt white and matt black

Socket Cover Plates - horizontal

Description	Available colours	Box qty	Cat ref.
Cover single socket	<input type="radio"/> Gloss White	5	★ WBQCP1
	<input checked="" type="radio"/> Matt Black	5	★ WBQCP1-MB
	<input type="radio"/> Matt White	5	★ WBQCP1-MW
Cover double socket	<input type="radio"/> Gloss White	5	★ WBQCP2
	<input checked="" type="radio"/> Matt Black	5	★ WBQCP2-MB
	<input type="radio"/> Matt White	5	★ WBQCP2-MW
Cover double socket with extra switch	<input type="radio"/> Gloss White	5	★ WBQCP2XS
	<input checked="" type="radio"/> Matt Black	5	★ WBQCP2XS-MB
	<input type="radio"/> Matt White	5	★ WBQCP2XS-MW



WBQCP1

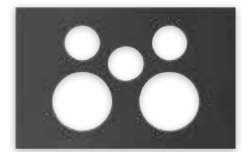

WBQCP2XS-MB

Socket Cover Plates - vertical

Description	Available colours	Box qty	Cat ref.
Cover single socket	<input type="radio"/> Gloss White	5	★ WBQCPV1
	<input checked="" type="radio"/> Matt Black	5	★ WBQCPV1-MB
	<input type="radio"/> Matt White	5	★ WBQCPV1-MW

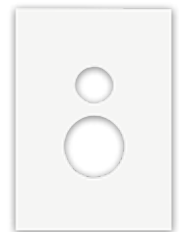

WBQCPV1

silhouette so fine, just stunning



Slim switches & sockets that blend into the wall have been a demand in the electrical industry for many years. silhouette has excelled in meeting this demand thanks to a thickness of only 4mm off the wall surface.

The silhouette range follows the Hager design philosophy – our design intention is to create meaningful, simple but elegant forms based on the serene balance of proportions.



Advantages:

- Slim 4mm profile off the wall surface
- Premium finish with real brushed aluminium and stainless steel materials.
- The small size socket base makes it easy to fit off with common mounting accessories.
- Electronic push button switches and dimmers fit into the range with our patented Rotoloc® system.

Characteristics:

- | | |
|-----------------------|---------------------------------|
| - External material: | - UV stabilised polycarbonate |
| - Switches terminals: | - 4 x 1.5mm ² cables |
| - Sockets terminals: | - 4 x 2.5mm ² cables |



01

With a thickness of only 4mm off the wall surface, silhouette has the lowest profile on the market.

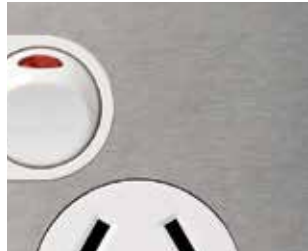

02

For maximum lustre, metal covers have a treated surface to reduce fingerprint marks.



03

Strong impact resistant polycarbonate material will not 'yellow' over time.



04

Our patented Rotoloc® system eliminates the possibility of the mechanism being pushed back into the wall cavity.



05

Generous slots for easy fitment with no need for screw caps to meet standards compliance.



06

A spring loaded shutter protects little fingers from live parts inside sockets.



07

Available in Matt Black, Matt White and Gloss White as well as Stainless steel and aluminium coverplates.



08

A full range of accessories and mechs including electronic push buttons and dimmers are available.

RotoLoc
 Featured in all switch plates

Features

- Multiple mounting holes
- Supplied with standard 32mm tapered point fixing screws
- No mechanism push back
- High impact high gloss UV stabilised Polycarbonate construction
- 16AX used as standard mechanisms (suitable for fluorescent loads)
- 2 way and loop terminal as standard
- Combination head screws Phillip's #1 'backed off' for ease of cable insertion
- Terminals accommodate 4 x 1.5mm² cable

Dimension data [Page 425](#)



WBSSP4

Switch Plates only - No Mechanisms

Description	Available colours	Box qty	Cat ref.
1 gang	<input type="radio"/> White	10	WBSSP1
	<input checked="" type="radio"/> Matt Black	10	WBSSP1-MB
	<input type="radio"/> Matt White	10	WBSSP1-MW
2 gang	<input type="radio"/> White	10	WBSSP2
	<input checked="" type="radio"/> Matt Black	10	WBSSP2-MB
	<input type="radio"/> Matt White	10	WBSSP2-MW
3 gang	<input type="radio"/> White	10	WBSSP3
	<input checked="" type="radio"/> Matt Black	10	WBSSP3-MB
	<input type="radio"/> Matt White	10	WBSSP3-MW
4 gang	<input type="radio"/> White	10	WBSSP4
	<input checked="" type="radio"/> Matt Black	10	WBSSP4-MB
	<input type="radio"/> Matt White	10	WBSSP4-MW
5 gang	<input type="radio"/> White	10	WBSSP5
	<input checked="" type="radio"/> Matt Black	10	WBSSP5-MB
	<input type="radio"/> Matt White	10	WBSSP5-MW
6 gang	<input type="radio"/> White	10	WBSSP6
	<input checked="" type="radio"/> Matt Black	10	WBSSP6-MB
	<input type="radio"/> Matt White	10	WBSSP6-MW
Blank	<input type="radio"/> White	10	WBSSP6



WBSSV1-MW



WBSSV1-MB

Switches

Description	Available colours	Box qty	Cat ref.
1 gang	<input type="radio"/> White	10	WBSSV1
	<input checked="" type="radio"/> Matt Black	10	WBSSV1-MB
	<input type="radio"/> Matt White	10	WBSSV1-MW
2 gang	<input type="radio"/> White	10	WBSSV2
	<input checked="" type="radio"/> Matt Black	10	WBSSV2-MB
	<input type="radio"/> Matt White	10	WBSSV2-MW
3 gang	<input type="radio"/> White	5	WBSSV3
	<input checked="" type="radio"/> Matt Black	5	WBSSV3-MB
	<input type="radio"/> Matt White	5	WBSSV3-MW
4 gang	<input type="radio"/> White	5	WBSSV4
	<input checked="" type="radio"/> Matt Black	5	WBSSV4-MB
	<input type="radio"/> Matt White	5	WBSSV4-MW
5 gang	<input type="radio"/> White	5	WBSSV5
	<input checked="" type="radio"/> Matt Black	5	WBSSV5-MB
	<input type="radio"/> Matt White	5	WBSSV5-MW
6 gang	<input type="radio"/> White	5	WBSSV6
	<input checked="" type="radio"/> Matt Black	5	WBSSV6-MB
	<input type="radio"/> Matt White	5	WBSSV6-MW
40A cooker switches 1 gang	<input type="radio"/> White	1	WBSSV6
	<input checked="" type="radio"/> Matt Black	1	WBSSV6-MB
	<input type="radio"/> Matt White	1	WBSSV6-MW

Features

- Removable covers for ease of painting
- Transparent blue mounting grid for easy installation
- Multiple mounting holes
- Terminal screws "backed off"
- Bevelled and colour coded cable entries aligned for ease of termination

- Supplied with standard tapered point 32mm fixing screws

Technical data

- All sockets 250V 50Hz rated
- Extra switch models fitted with 16AX mechanisms
- Hi impact high gloss UV stabilised Polycarbonate construction

- Terminal accommodates 4 x 2.5mm² cable
- Electronic PB switches are 5A

Dimension data [Page 425](#)

Sockets - horizontal

Description	Characteristics	Available colours	Box qty	Cat ref.
Single sockets	10A	○ White	10	WBSP1S
		● Matt Black	10	WBSP1S-MB
		○ Matt White	10	WBSP1S-MW
	10A 'Round Earth'	○ White	10	WBSP1R
		● Matt Black	10	WBSP1R-MB
	15A	○ White	5	WBSP115S
		● Matt Black	5	WBSP115S-MB
		○ Matt White	5	WBSP115S-MW
	Double sockets	10A	○ White	10
● Matt Black			10	WBSP2S-MB
○ Matt White			10	WBSP2S-MW
Double socket with extra switch	10A	○ White	5	WBSP2XS
		● Matt Black	5	WBSP2XS-MB
		○ Matt White	5	WBSP2XS-MW
Double sockets with USB Type A and Type C	10A	○ White	1	★ WBSP2SUSBAC
		● Matt Black	1	★ WBSP2SUSBAC-MB
		○ Matt White	1	★ WBSP2SUSBAC-MW



Sockets - vertical

Description	Characteristics	Available colours	Box qty	Cat ref.
Single sockets	10A	○ White	5	WBSP1VS
		● Matt Black	5	WBSP1VS-MB
		○ Matt White	5	WBSP1VS-MW



Electronic Push Button Switches

Description	Available colours	Box qty	Cat ref.
1 gang	○ White	1	WBSEV1
2 gang	○ White	1	WBSEV2
3 gang	○ White	1	WBSEV3
4 gang	○ White	1	WBSEV4
5 gang	○ White	1	WBSEV5
6 gang	○ White	1	WBSEV6



Features

- Hi impact high gloss UV stabilised Polycarbonate, real aluminium or real stainless steel construction
- Matt black, white or clear anodized aluminium or brushed stainless steel finish, to reduce finger printing

Dimension data [Page 425](#)

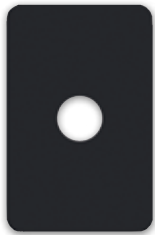

WBSCV1-MB



WBSCV2-AL

Switch Covers

Description	Available colours	Box qty	Cat ref.
1 gang	Gloss White	5	WBSCV1
	Matt Black	5	WBSCV1-MB
	Matt White	5	WBSCV1-MW
	Aluminium	5	WBSCV1-AL
	Stainless Steel	5	WBSCV1-SS
2 gang	Gloss White	5	WBSCV2
	Matt Black	5	WBSCV2-MB
	Matt White	5	WBSCV2-MW
	Aluminium	5	WBSCV2-AL
	Stainless Steel	5	WBSCV2-SS
3 gang	Gloss White	5	WBSCV3
	Matt Black	5	WBSCV3-MB
	Matt White	5	WBSCV3-MW
	Aluminium	5	WBSCV3-AL
	Stainless Steel	5	WBSCV3-SS
4 gang	Gloss White	5	WBSCV4
	Matt Black	5	WBSCV4-MB
	Matt White	5	WBSCV4-MW
	Aluminium	5	WBSCV4-AL
	Stainless Steel	5	WBSCV4-SS
5 gang	Gloss White	5	WBSCV5
	Matt Black	5	WBSCV5-MB
	Matt White	5	WBSCV5-MW
	Aluminium	5	WBSCV5-AL
	Stainless Steel	5	WBSCV5-SS
6 gang	Gloss White	5	WBSCV6
	Matt Black	5	WBSCV6-MB
	Matt White	5	WBSCV6-MW
	Aluminium	5	WBSCV6-AL
	Stainless Steel	5	WBSCV6-SS
Blank	Matt Black	5	WBSCPB-MB
	Matt White	5	WBSCPB-MW
Special Application Plate Suits WBSSEA2	Aluminium	5	WBSCSEA2-AL
	Stainless Steel	5	WBSCSEA2-SS

Features

- Hi impact high gloss UV stabilised Polycarbonate
- Spray matt finishes available in matt white and matt black

Dimension data [Page 425](#)

Socket Covers - horizontal

Description	Available colours	Box qty	Cat ref.
Cover single socket	<input type="radio"/> Gloss White	5	WBSCP1
	<input checked="" type="radio"/> Matt Black	5	WBSCP1-MB
	<input type="radio"/> Matt White	5	WBSCP1-MW
	<input type="radio"/> Aluminium	5	WBSCP1-AL
	<input type="radio"/> Stainless Steel	5	WBSCP1-SS
Cover double socket	<input type="radio"/> Gloss White	5	WBSCP2
	<input checked="" type="radio"/> Matt Black	5	WBSCP2-MB
	<input type="radio"/> Matt White	5	WBSCP2-MW
	<input type="radio"/> Aluminium	5	WBSCP2-AL
	<input type="radio"/> Stainless Steel	5	WBSCP2-SS
Cover double socket with extra switch	<input type="radio"/> Gloss White	5	WBSCP2X
	<input checked="" type="radio"/> Matt Black	5	WBSCP2X-MB
	<input type="radio"/> Matt White	5	WBSCP2X-MW
	<input type="radio"/> Aluminium	5	WBSCP2X-AL
	<input type="radio"/> Stainless Steel	5	WBSCP2X-SS

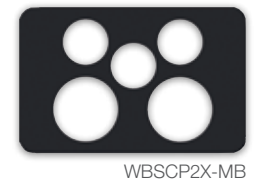

Socket Covers - vertical

Description	Available colours	Box qty	Cat ref.
Cover single socket	<input type="radio"/> Gloss White	5	WBSVCP1
	<input checked="" type="radio"/> Matt Black	5	WBSVCP1-MB
	<input type="radio"/> Aluminium	5	WBSVCP1-AL
	<input type="radio"/> Stainless Steel	5	WBSVCP1-SS



premiere

An award-winning modern day classic

When the space demands accessories that don't dominate, choose a design that combines classic aesthetics with modern day benefits for a simple and stylish look.

Quietly offering functionality and a beautifully understated form, you can now add a finishing touch to your decor with premiere Switches and Sockets.



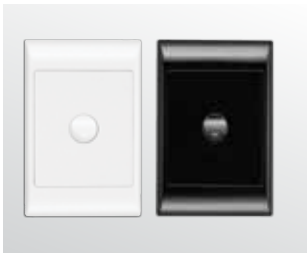

01

Available in white and black colour options.



02

Strong impact resistant polycarbonate material will not 'yellow' over time.



03

A spring loaded shutter protects little fingers from live parts inside sockets.



04

Our patented Rotoloc® system eliminates the possibility of the mechanism being pushed back into the wall cavity.

Features

- Transparent mounting grid for easy installation
- Multiple mounting holes
- Supplied with standard 32mm tapered point fixing screws
- No mechanism push back
- High impact, high gloss UV stabilised polycarbonate construction
- Removable surrounds for ease of painting

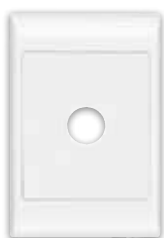

WBSP1



WBSP2-BK

Switch Plates only - No Mechanisms

Description	Available colours	Box qty	Cat ref.
1 gang	○ Gloss White	10	WBSP1
	● Black	10	WBSP1-BK
2 gang	○ Gloss White	10	WBSP2
	● Black	10	WBSP2-BK
3 gang	○ Gloss White	10	WBSP3
	● Black	10	WBSP3-BK
4 gang	○ Gloss White	10	WBSP4
	● Black	10	WBSP4-BK
5 gang	○ Gloss White	10	WBSP5
	● Black	10	WBSP5-BK
6 gang	○ Gloss White	10	WBSP6
	● Black	10	WBSP6-BK
Blank	○ Gloss White	10	WBSPB

Features

- Transparent mounting grid for easy installation
- Multiple mounting holes
- Supplied with standard 32mm tapered point fixing screws
- No mechanism push back
- High impact, high gloss UV stabilised polycarbonate construction
- Removable surrounds for ease of painting
- Rocker features in-built arc shield and chemical resistant pivots
- All plates fitted with 16AX mechanisms (suitable for fluorescent loads)
- 2 way and loop terminal as standard
- Combination head screws Phillip's #1 'backed off' for ease of cable insertion
- Terminals accommodate 4 x 1.5mm² cable

Dimension data [Page 430](#)



Large Plate Switches - vertical

Description	Available colours	Box qty	Cat ref.
1 gang	○ Gloss White	10	WBSV1
	● Black	10	WBSV1-BK
2 gang	○ Gloss White	10	WBSV2
	● Black	10	WBSV2-BK
3 gang	○ Gloss White	5	WBSV3
	● Black	5	WBSV3-BK
4 gang	○ Gloss White	5	WBSV4
	● Black	5	WBSV4-BK
5 gang	○ Gloss White	5	WBSV5
	● Black	5	WBSV5-BK
6 gang	○ Gloss White	5	WBSV6
	● Black	5	WBSV6-BK



WBSV1-BK

Large Plate switches - horizontal

Description	Available colours	Box qty	Cat ref.
1 gang	○ Gloss White	10	WBSH1
2 gang	○ Gloss White	10	WBSH2
3 gang	○ Gloss White	5	WBSH3



WBSH2

Architrave Switches features

- Supplied with both a premiere and a visage cover for your choice
- Common cover and mounting centres
- Supplied with 12mm tapered point fixing screws

Fan Controller features

- Fan knobs cannot be removed once installed into plate

Card Entry features

- Micro switch controlled
- Supplied with card

Dimension data [Page 431](#)



WBSA1-BK

Architrave Switches

Description	Available colours	Box qty	Cat ref.
1 gang	<input type="radio"/> Gloss White	10	WBSA1
	<input checked="" type="radio"/> Black	10	WBSA1-BK
2 gang	<input type="radio"/> Gloss White	10	WBSA2
	<input checked="" type="radio"/> Black	10	WBSA2-BK
3 gang	<input type="radio"/> Gloss White	5	WBSA3
	<input checked="" type="radio"/> Black	5	WBSA3-BK



WBSF3

Other products

Description	Available colours	Box qty	Cat ref.
Fan controller	<input type="radio"/> Gloss White	1	WBSF3
3 speed capacitance 250V 75A	<input checked="" type="radio"/> Black	1	WBSF3-BK
TV plate - PAL 75 OHM	<input type="radio"/> Gloss White	10	WBTV75
TV plate - 'F' to 'F' pay TV	<input type="radio"/> Gloss White	10	WBTV75PY
Permanent connection plate	<input type="radio"/> Gloss White	5	WBPPCU

Features

- Removable surrounds for ease of painting
- Transparent mounting grid for easy installation
- Multiple mounting holes
- Supplied with standard 32mm fixing screws
- High impact, high gloss UV stabilised polycarbonate

IP66 features

- 16A rated mechanism
- 2 way as standard
- Loop terminal as standard
- Terminals take 4 x 1.5mm² cable
- All IP66 switches can be mounted onto the WBBMI for surface mounting

- Designed to ensure IP66 when installed on suitable flat, smooth, non water absorbent surfaces
- Factory sealed IP tested gaskets
- IP rating maintained with sealing plugs in place

Dimension data [Page 431](#)



IP66 Large Plate Switches - vertical

Description	Available colours	Box qty	Cat ref.
1 gang	○ Gloss White	1	WBWSV1
	● Black	1	WBWSV1-BK
2 gang	○ Gloss White	1	WBWSV2
	● Black	1	WBWSV2-BK
3 gang	○ Gloss White	1	WBWSV3
	● Black	1	WBWSV3-BK
4 gang	○ Gloss White	1	WBWSV4
	● Black	1	WBWSV4-BK
3 gang with Light/Fan/Heat printed mechs	○ Gloss White	1	WBWSV3LFH
	● Black	1	WBWSV3LFH-BK
4 gang with Light/Fan/Heat/Heat printed mechs	○ Gloss White	1	WBWSV4LFHH
	● Black	1	WBWSV4LFHH-BK



WBWSV3LFH



WBWSV4LFHH-BK

IP66 Large Plate Switches - horizontal

Description	Available colours	Box qty	Cat ref.
1 gang	○ Gloss White	1	WBWSH1
	● Black	1	WBWSH1-BK
2 gang	○ Gloss White	1	WBWSH2
	● Black	1	WBWSH2-BK
3 gang	○ Gloss White	1	WBWSH3
	● Black	1	WBWSH3-BK
4 gang	○ Gloss White	1	WBWSH4
	● Black	1	WBWSH4-BK
3 gang with Light/Fan/Heat printed mechs	○ Gloss White	1	WBWSH3LFH
	● Black	1	WBWSH3LFH-BK
4 gang with Light/Fan/Heat/Heat printed mechs	○ Gloss White	1	WBWSH4LFHH
	● Black	1	WBWSH4LFHH-BK



WBWSH3LFH



WBWSH4LFHH-BK

Features

- Common cover
- Removable covers for ease of painting
- Transparent mounting grid for easy installation
- Multiple mounting holes
- Terminal screws "backed off"

- Bevelled and colour coded cable entries aligned for ease of termination
- Supplied with standard tapered point 32mm fixing screws

Technical data

- All sockets 250V 50Hz rated
- Extra switch models fitted with 16AX mechanisms
- High impact, high gloss UV stabilised polycarbonate construction
- Terminal accommodates 4 x 2.5mm² cable



Dimension data [Page 430](#)



WBP1S



WBP115S-BK

Single Sockets - horizontal

Description	Available colours	Box qty	Cat ref.
10A	○ Gloss White	10	WBP1S
	● Black	10	WBP1S-BK
15A	○ Gloss White	5	WBP115S
	● Black	5	WBP115S-BK
20A	○ Gloss White	5	WBP120
10A double pole	○ Gloss White	10	WBP1DS
15A	○ Gloss White	5	WBP115DS
10A with extra switch	○ Gloss White	5	WBP1XS
	● Black	5	WBP1XS-BK
10A with 2 extra switches	○ Gloss White	5	WBP1XXS
	● Black	5	WBP1XXS-BK
10A with round earth pin	○ Gloss White	5	WBP1R
	● Black	5	WBP1R-BK



WBP1VS



WBP1VXS-BK

Single Sockets - vertical

Description	Available colours	Box qty	Cat ref.
10A	○ Gloss White	5	WBP1VS
	● Black	5	WBP1VS-BK
	● Red	5	WBP1VS-RD
15A	○ Gloss White	5	WBP115VS
	● Black	5	WBP115VS-BK
10A with extra switch	○ Gloss White	5	WBP1VXS
	● Black	5	WBP1VXS-BK
10A with 2 extra switches	○ Gloss White	5	WBP1VXXS
	● Black	5	WBP1VXXS-BK

Features

- Common cover
- Removable covers for ease of painting
- Transparent mounting grid for easy installation
- Multiple mounting holes
- Terminal screws "backed off"
- Bevelled and colour coded cable entries aligned for ease of termination
- Supplied with standard tapered point 32mm fixing screws
- 4 outlet sockets have same mounting centres as double socket outlets.

Technical data

- All sockets 250V 50Hz rated with 16AX mechanisms
- Extra switch models fitted with 16AX mechanisms
- High impact high gloss UV stabilised polycarbonate construction
- Terminal accommodates 4 x 2.5mm² cable

Dimension data [Page 430 and 431](#)



Double Sockets - horizontal

Description	Available colours	Box qty	Cat ref.
10A	○ Gloss White	10	WBP2S
	● Black	10	WBP2S-BK
	● Red	10	WBP2S-RD
10A double pole	○ Gloss White	10	WBP2DS
10A with extra switch	○ White	5	WBP2XS
	● Black	5	WBP2XS-BK
10A with circuit id	○ Gloss White	10	WBP2CID
	● Black	10	WBP2CID-BK
Double sockets + USB Type A and C	○ Gloss White	1	WBP2SUSBAC



WBP2S

Double Sockets - vertical

Description	Available colours	Box qty	Cat ref.
10A	○ Gloss White	10	WBP2VS
	● Black	10	WBP2VS-BK
10A with extra switch	○ Gloss White	5	WBP2VXS
	● Black	5	WBP2VXS-BK



WBP2VS

4 Outlet Sockets - horizontal

Description	Available colours	Box qty	Cat ref.
10A	○ Gloss White	4	WBP4S
	● Black	4	WBP4S-BK
10A with extra switch	○ Gloss White	4	WBP4XS
	● Black	4	WBP4XS-BK



WBP4S



WBP4XS

Switches and sockets

Features

- Surrounds to fit to premiere range
- Easily removable for cleaning
- Manufactured from tempered glass, slate or polycarbonate



WBC2V

Standard Polycarbonate Surrounds

Description	Available colours	Box qty	Cat ref.
Single product surround	○ Gloss White	10	WBC1Z
	● Black	10	WBC1Z-BK
2 product vertical surround	○ Gloss White	10	WBC2V
	● Black	10	WBC2V-BK
2 product horizontal surround	○ Gloss White	10	WBC2H
	● Black	10	WBC2H-BK

Features

- HDMI modules can be easily mounted into any of the 'SEA2' plates
- The HDMI connection can be used in conjunction with HD TV and Audio devices

Dimension data:

[Page 427, 429](#)

HDMI Connection Modules

Description	Available colours	Box qty	Cat ref.
HDMI passthrough	<input type="radio"/> White	1	★ WS263



WS263

silhouette Module Plates

Description	Available colours	Box qty	Cat ref.
2 module	<input type="radio"/> White	10	WBSSEA2



WBSSEA2

allure Module Plates

Description	Available colours	Box qty	Cat ref.
2 module	<input type="radio"/> White	10	★ WBHSEA2
	<input checked="" type="radio"/> Matt Black	10	★ WBHSEA2-MB
	<input type="radio"/> Matt White	10	★ WBHSEA2-MW
3 module	<input type="radio"/> White	10	★ WBHSEA3
	<input checked="" type="radio"/> Matt Black	10	★ WBHSEA3-MB
	<input type="radio"/> Matt White	10	★ WBHSEA3-MW



WBHSEA2

finesse Module Plates

Description	Available colours	Box qty	Cat ref.
2 module plate	<input type="radio"/> White	10	★ WBQSEA2
	<input checked="" type="radio"/> Matt Black	10	★ WBQSEA2-MB
	<input type="radio"/> Matt White	10	★ WBQSEA2-MW
3 module	<input type="radio"/> White	10	★ WBQSEA3
	<input checked="" type="radio"/> Matt Black	10	★ WBQSEA3-MB
	<input type="radio"/> Matt White	10	★ WBQSEA3-MW

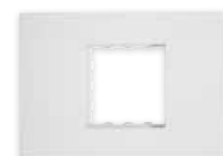

WBQSEA2

Technical information [Page 432](#)

Features:

- Slave Push Button Switch available
- All electronic mechanisms are EMC compliant
- Supplied with White, Matt Black and Matt White caps or rotary knob



WBME5A

Electronic Push Button Switch Mechanism

Description	Available colours	Box qty	Cat ref.
230/240V AC 1200W	○ White Complete with MB and MW interchangeable coloured caps	5	WBME5A



WBMDUPB

Electronic Push Button Universal Dimmer Mechanism

Description	Available colours	Box qty	Cat ref.
250W - LED loads 300W - Incandescent loads	○ White Complete with MB and MW interchangeable coloured caps	5	★ WBMDUPB



WBMDUR

Electronic Universal Rotary Dimmer Mechanism

Description	Available colours	Box qty	Cat ref.
250W - LED loads 300W - Incandescent loads	○ White Complete with MB and MW knobs	5	★ WBMDUR



WBMSLL

Electronic Push Button Slave Mechanism

Description	Available colours	Box qty	Cat ref.
To be used only in conjunction with either WBMDUPB, WBMDUR or WBME5A.	○ White Complete with MB and MW interchangeable coloured caps	5	★ WBMSLL



WBAEDB

Dimmer Caps and Knobs

Description	Available colours	Cat ref.
Dimmer caps for WBMDUPB and WBMSLL	○ Gloss White	★ WBAEDB
	● Gloss Black	★ WBAEDB-BK
	● Matt Black	★ WBAEDB-MB
	○ Matt White	★ WBAEDB-MW
Dimmer knob for WBMDUR	○ Gloss White	★ WBAEDK
	● Gloss Black	★ WBAEDK-BK
	● Matt Black	★ WBAEDK-MB
	○ Matt White	★ WBAEDK-MW



WBAEDK-MB

Features

- Easy mechanism removal
- Rear housing colour coded for easy recognition of mechanism type
- All terminal screws are combination head Phillips No. 1 and backed off

Technical data:

- 3mm contact gap in WBM16AX
- All 250V mechanism's have M60 motor rating
- 32A and 20AX mechanism 'socket size' terminal accommodates 2 x 4mm² cables
- Intermediate and double pole have 75% of terminal screws accessible from 1 direction
- Terminals accommodate 4 x 1.5mm² cables
- Push mech rated at 10A
- Tactile mech rated 6A

Technical information Page 433, 434



250V PB Mechanisms

Description	Available colours	Box qty	Cat ref.
LED for push button	<input type="radio"/> Blue	20	★ WBAPBLED
10A flush push button - 2 way	<input type="radio"/> White	5	★ WBMPB
	<input checked="" type="radio"/> Matt Black	5	★ WBMPB-MB
	<input type="radio"/> Matt White	5	★ WBMPB-MW
6A 240V push button tactile/momentary mech (Available early 2022)	<input type="radio"/> White	5	★ WBMPB
	<input checked="" type="radio"/> Matt Black	5	★ WBMPB-MB
	<input type="radio"/> Matt White	5	★ WBMPB-MW



WBMPB

250V Mechanisms

Description	Available colours	Box qty	Cat ref.
16A AX rated STANDARD	<input type="radio"/> White	5	WBM16AX
	<input checked="" type="radio"/> Black	5	WBM16AX-BK
	<input type="radio"/> Matt White	5	WBM16AX-MW
	<input checked="" type="radio"/> Matt Black	5	WBM16AX-MB
	<input checked="" type="radio"/> Red	5	WBM16AX-RD
20A Standard	<input type="radio"/> White	5	WBM20
	<input checked="" type="radio"/> Black	5	WBM20-BK
	<input type="radio"/> Matt White	5	WBM20-MW
	<input checked="" type="radio"/> Matt Black	5	WBM20-MB
16A AX rated with lens	<input type="radio"/> White	5	WBM16AXL
	<input checked="" type="radio"/> Black	5	WBM16AXL-BK
16A AX rated with neon light	<input type="radio"/> White	5	WBM16AXN
10A double pole	<input type="radio"/> White	5	WBM10D
	<input checked="" type="radio"/> Black	5	WBM10D-BK
	<input type="radio"/> Matt White	5	WBM10D-MW
	<input checked="" type="radio"/> Matt Black	5	WBM10D-MB
10A intermediate	<input type="radio"/> White	5	WBM10I
	<input checked="" type="radio"/> Black	5	WBM10I-BK
	<input type="radio"/> Matt White	5	WBM10I-MW
	<input checked="" type="radio"/> Matt Black	5	WBM10I-MB
20A AX rated 1 way only	<input type="radio"/> White	5	WBM20AX
	<input checked="" type="radio"/> Black	5	WBM20AX-BK
	<input type="radio"/> Matt White	5	WBM20AX-MW
	<input checked="" type="radio"/> Matt Black	5	WBM20AX-MB
32A 1 way only	<input type="radio"/> White	5	WBM32
	<input checked="" type="radio"/> Black	5	WBM32-BK
	<input type="radio"/> Matt White	5	WBM32-MW
	<input checked="" type="radio"/> Matt Black	5	WBM32-MB
15A press	<input type="radio"/> White	5	WBM15P
	<input type="radio"/> Matt White	5	WBM15P-MW
	<input checked="" type="radio"/> Matt Black	5	WBM15P-MB
15A without printed "press"	<input type="radio"/> White	5	WBM15PB
	<input type="radio"/> Matt White	5	WBM15PB-MW
	<input checked="" type="radio"/> Matt Black	5	WBM15PB-MB



WBM16AX
Standard Mechanism



WBM16AXL



WBM16AXN



WBM10D-MB



WBM10I-MB



WBM15P-MB

Features

- Easy mechanism removal
- Rear housing colour coded for easy recognition of mechanism type
- All terminal screws are combination head Phillips No. 1 and backed off

Technical data

- 3mm contact gap in WBM16AX
- All 250V mechanism's have M60 motor rating
- Intermediate and double pole have 75% of terminal screws accessible from 1 direction
- 10A, 16AX and 20A terminals accommodate 4 x 1.5mm² cables
- Push mech rated at 10A

- 32A and 20AX mechanism 'socket size' terminal accommodates 2 x 4mm² cables

Technical information

[Page 434](#)



WBM16L



WBM20F



WBM20H



WBM32HO



WBM32O

250V Printed Mechanisms

Description	Available colours	Box qty	Cat ref.
'LIGHT' 16A AX 2 way	<input type="radio"/> White	5	WBM16L
	<input checked="" type="radio"/> Black	5	WBM16L-BK
	<input type="radio"/> Matt White	5	WBM16L-MW
	<input checked="" type="radio"/> Matt Black	5	WBM16L-MB
'FAN' 20A 1 way	<input type="radio"/> White	5	WBM20F
	<input checked="" type="radio"/> Black	5	WBM20F-BK
	<input type="radio"/> Matt White	5	WBM20F-MW
	<input checked="" type="radio"/> Matt Black	5	WBM20F-MB
'HEAT' 20A 1 way	<input type="radio"/> White	5	WBM20H
	<input checked="" type="radio"/> Black	5	WBM20H-BK
	<input type="radio"/> Matt White	5	WBM20H-MW
	<input checked="" type="radio"/> Matt Black	5	WBM20H-MB
'HOT WATER' 20A 1 way	<input type="radio"/> White	5	WBM20HW
'HOT WATER' 32A 1 way	<input checked="" type="radio"/> Matt Black	5	WBM32HW-MB
	<input type="radio"/> Matt White	5	WBM32HW-MW
'SENSOR' 20A 1 way	<input type="radio"/> White	5	WBM20SN
'HOB' 32A 1 way	<input type="radio"/> White	5	WBM32HO
	<input checked="" type="radio"/> Black	5	WBM32HO-BK
	<input type="radio"/> Matt White	5	WBM32HO-MW
	<input checked="" type="radio"/> Matt Black	5	WBM32H-MB
'OVEN' 32A 1 way	<input type="radio"/> White	5	WBM32O
	<input checked="" type="radio"/> Black	5	WBM32O-BK
	<input type="radio"/> Matt White	5	WBM32O-MW
	<input checked="" type="radio"/> Matt Black	5	WBM32O-MB
'RANGE' 32A 1 way	<input type="radio"/> White	5	WBM32R
	<input checked="" type="radio"/> Black	5	WBM32R-BK
	<input type="radio"/> Matt White	5	WBM32R-MW
	<input checked="" type="radio"/> Matt Black	5	WBM32R-MB

Feature

- Easy mechanism removal

Technical data

- Terminals accommodate 4 x 1.5mm² cables

Technical information [Page 434](#)



250V Rotary Mechanisms

Description	Available colours	Box qty	Cat ref.
10A 3 position rotary	○ White	10	WBM10R3
10A 3 pos. rotary - w/ capacitor (fan)	● Matt Black	10	WBMSF3-MB
	○ Matt White	10	WBMSF3-MW
10A 3 pos. rotary - Auto/Manual	○ White	10	WBM10RAM
10A 3 pos. rotary - Lo/Hi	○ White	10	WBM10RLH
10A 3 pos. rotary - Sensor	○ White	10	WBM10RSN
10A 3 pos. rotary - Up/Down	○ White	10	WBM10RUD
Rotary Knob to suit rotary mechs	○ White	10	WBARK1
	● Black	10	WBARK1-BK
	○ Matt White	10	WBARK1-MW
	● Matt Black	10	WBARK1-MB



WBM10R3



WBARK1

Rotoloc Data Mechanisms

- Data Mechs are tested and approved to the following standards where relevant:

ANSI/TIA-568-C.2-2009
ISO/IEC 11801-1
IEC 60603-7-2
AS/CA S008:2015I

Audio Connectors

- RCA jacks have 'F' connection at rear
- Available in multiple colours for maximum installation flexibility
- Speaker connectors suitable for both bare wire termination and banana plugs

Technical information:

[Page 439, 440](#)



WBMTV75PF



WBMTV75PY-MB

TV Mechanisms

Description	Available colours	Box qty	Cat ref.
'F' to PAL type mechanism	○ White	10	WBMTV75PF
	● Black	10	WBMTV75PF-BK
	○ Matt White	10	WBMTV75PF-MW
	● Matt Black	10	WBMTV75PF-MB
TV socket mechanism 3GHz 75Ohm Foxtel approved	○ White	10	WBMTV75PY
	● Black	10	WBMTV75PY-BK
	○ Matt White	10	WBMTV75PY-MW
	● Matt Black	10	WBMTV75PY-MB



WBMCAT6-MW



WBMCAT6A

Rotoloc Data Mechanisms

Description	Available colours	Box qty	Cat ref.
8 Pin Cat5e	○ White	10	WBMCAT5
8 Pin Cat6	○ White	10	WBMCAT6
	● Black	10	WBMCAT6-BK
	○ Matt White	10	WBMCAT6-MW
	● Matt Black	10	WBMCAT6-MB
8 Pin Cat6A	○ White	10	WBMCAT6A



WBMHDMI

Audio Connectors

Description	Available colours	Box qty	Cat ref.
M/M HDMI pass through	○ White	5	WBMHDMI
	● Matt Black	5	WBMHDMI-MB
	○ Matt White	5	WBMHDMI-MW
RCA connectors for composite audio/video - 1 x red, 1 x white, 1 x yellow	○ White	5	WBMRCA1
	● Black	5	WBMRCA1-BK

Circuit ID features:

- Circuit ID cannot be removed from front of plate once installed

Technical data

- Cord grip mechanism will accept light and heavy duty flexible cables
- Circuit ID labels supplied in sheets of 10, A4 size.



Special Mechanisms

Description	Available colours	Box qty	Cat ref.
Cord grip mechanism	○ White	5	WBMPCU
Circuit ID mechanism	○ White	5	WBMCID
Blank mechanism	○ White	5	WBMBP
	● Black	5	WBMBP-BK
ELV tactile mechanism extra low voltage tactile switch momentary contact	○ White	5	WBMLVT
	● Black	5	WBMLVT-BK
	○ Matt White	5	WBMLVT-MW
ELV tactile mechanism + neon extra low voltage tactile switch with LED indication momentary contact	○ White	5	WBMLVTN
	● Black	5	WBMLVTN-BK
	○ Matt White	5	WBMLVTN-MW
	● Matt Black	5	WBMLVTN-MB
Neon lights	250V Neon – red	5	WBM250NRD
	250V Neon – amber	5	WBM250NAM
	250V Neon – green	5	WBM250NGR
	250V Neon – clear	5	WBM250NCL
USB Mechanism 1 x TYPE A 1 x TYPE C	○ White	1	★ WBMUSBAC
	● Black	1	★ WBMUSBAC-BK
	○ Matt White	1	★ WBMUSBAC-MW
	● Matt Black	1	★ WBMUSBAC-MB



Mounting Block features

- Hi Impact UV stabilised Polycarbonate
- Compatible with all large plate switches and sockets

Surface sockets features

- Safety Shroud for extra security and safety.
- Can be tested when fitted to mounting plate

Dimension data [Page 441](#)



WBBMD



WBSBMD



WBBMI

Mounting Accessories

Description	Available colours	Box qty	Cat ref.
premiere Mounting block 32mm deep	○ White	5	WBBMD
	● Black	5	WBBMD-BK
silhouette mounting block 32mm deep	○ White	5	WBSBMD
	● Matt Black	5	WBSBMD-MB
allure mounting block	○ White	5	★ WBHMBD
	● Matt Black	5	★ WBHMBD-MB
finesse mounting block 84mm interaxe	○ White	5	★ WBQMBD
	● Matt Black	5	★ WBQMBD-MB
premiere Mounting block 18mm deep	○ White	5	WBBMS
premiere Mounting block to suit 4 gang outlet	○ White	4	WBBM4
Insulated back to suit 4 gang mounting block	○ White	8	WBBM4BP
premiere Insulated mounting block 32mm deep	○ White	10	WBBMI
	● Black	10	WBBMI-BK
premiere Surface mounting kit 29mm deep suits premiere plates only	○ White	5	WBBSMK
	● Black	5	WBBSMK-BK
Wall box 1 gang moulded plastic		10	WBBWB



WBAP1

Surface Sockets

Description	Characteristics	Available colours	Box qty	Cat ref.
Single surface sockets	10A	○ White	10	WBAP1
	15A	○ White	10	WBAP115
with round earth pin	10A	○ White	10	WBAP1R
Replacement mounting plate			30	WBAP1MP

Junction Box feature

- Includes quickfix screws and terminal connectors

Dimension data [Page 441](#)

Shrouds

- Shroud for insulating live parts

Junction Boxes

Description	Available colours	Box qty	Cat ref.
Giant junction box with quick fix screws and 4 cable connectors	○ White	5	WBAJB4
Standard junction box with quick fix screws and 3 cable connectors	○ White	10	WBAJB4S



Shrouds and Covers

Description	Box qty	Cat ref.
Insulating shroud size 2 suits premiere products	10	WBBS2
Paint cover suits premiere products only	30	WBAPC

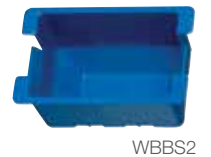

Miscellaneous

Description	Box qty	Cat ref.
M3.5 X 50mm long pan head tapered point mounting screw 50 screws per box	50	WBASC50
Mechanism removal tool		WBMS
Screw connectors - single	100	WBAC1B
Screw connectors - twin	50	WBAC2B



Description

Our surface mounted range of IP rated switches and sockets are designed for outdoor applications. Easy to install with two single screws fixing the top cover to the base.

Electrical Specification

Switch - 16A, 250V AC
Single pole 2 way with loop
Socket - 10/15A, 250V AC
Single pole

Dimension data [Page 442](#)

Mechanical specification

- IP66 for switches
- IP53 for sockets
- External material is UV stabilised polycarbonate



WBWS216

Switches

Description	Characteristics	Box qty	Cat ref.
16A IP66 switches	1 gang	1	WBWS116
	2 gang	1	WBWS216



WBWP1S

Single Sockets

Description	Characteristics	Box qty	Cat ref.
IP53 single socket	10A	1	WBWP1S
	15A	1	WBWP115S
IP53 single socket (White)	10A	1	★ WBWP1S-W
	15A	1	★ WBWP115S-W



WBWP2S

10A Double Sockets

Description	Characteristics	Box qty	Cat ref.
10A, IP53 double socket		1	WBWP2S
	shallow mount	1	WBWP2SH
10A, IP53 double socket (White)		1	★ WBWP2S-W
	shallow mount	1	★ WBWP2SH-W



WBWP2SH

Description

Our range of Weatherproof Isolators are designed to be used in indoor or outdoor applications with IP66 degree of protection. They are switch disconnectors for 2, 3 and 4 pole supply, from 20A to 63A. Rated at AC-23A, they can also be used to isolate motor/compressor loads without derating. They provide ample wiring room and are easy to install with a 2 screw quick release top cover.

Electrical Specification

- AS/NZS IEC 60947-3
- Rated voltage:
250V AC 50/60Hz
440V AC 50/60Hz
- Utilization category
AC-21A, AC-22A, AC-23A for switching any type of load from resistive to highly inductive loads

Mechanical Specification

- IP66
- External material is UV stabilised polycarbonate
- Ø25mm top and bottom cable entry hole caps
- Ø25mm and Ø20mm conduit entry knock-cuts
- Ø20mm mounting holes
- Handle provides Ø6mm shank padlocking facility (ON & OFF position)

Technical information [Page 443](#)

2 pole Isolators

Description	Characteristics	Operational power input			Box qty	Cat ref.
		AC-21A	AC-22A	AC-23A		
IP66 	20A	4.8kW	4.0kW	3.3kW	1	JG220IN
	32A	7.6kW	6.4kW	5.2kW	1	JG232IN
	40A	9.5kW	8.0kW	6.5kW	1	JG240IN
	63A	15kW	12.6kW	10.2kW	1	JG263IN



JG240IN

3 pole Isolators

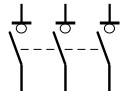
Description	Characteristics	Operational power input			Box qty	Cat ref.
		AC-21A	AC-22A	AC-23A		
IP66 	20A	14.5kW	12.2kW	9.9kW	1	JG320IN
	32A	23.2kW	19.5kW	15.9kW	1	JG332IN
	40A	29kW	24.4kW	19.8kW	1	JG340IN



JG340IN

4 pole Isolators

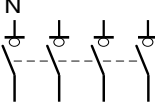
Description	Characteristics	Operational power input			Box qty	Cat ref.
		AC-21A	AC-22A	AC-23A		
IP66 N 	20A	14.5kW	12.2kW	9.9kW	1	JG420IN
	32A	23.2kW	19.5kW	15.9kW	1	JG432IN
	40A	29kW	24.4kW	19.8kW	1	JG440IN
	63A	45.6kW	38.4kW	31.2kW	1	JG463IN



JG440IN

Regulatory Compliance Mark (RCM)



	Product	Max No. of cable cores to each terminal hole					Motor rating
		1.0mm ²	1.5mm ²	2.5mm ²	4.0mm ²	6.0mm ²	
Switch mechanisms	10A mechanism		4				M40
	16A mechanism		4				M60
	16AX mechanism		4				M60
	20A mechanism		4				M60
	20AX mechanism				2		M80
	32A mechanism				2		M80
	Card entry switches		4				N/A
Sockets	10A mechanism			4			N/A
	15A mechanism			4			N/A
	20A mechanism			4			N/A
	Screw connectors			4	3	2	N/A

Motor Rating - Indicated on the mechanism as Mxx, where xx is the nominated locked rotor current in amperes (as per AS/NZS3133:2008)

Switches and sockets cutout dimensions

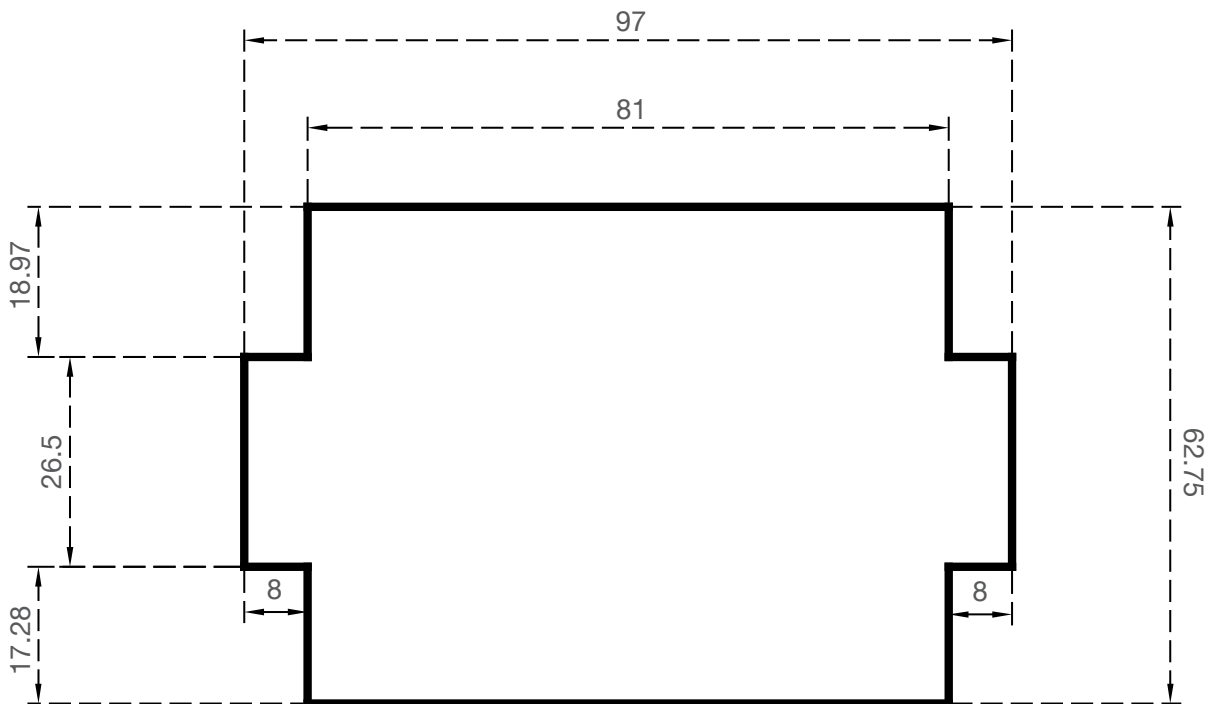

Cut out (mm) - Suits allure, finesse, silhouette & premiere ranges

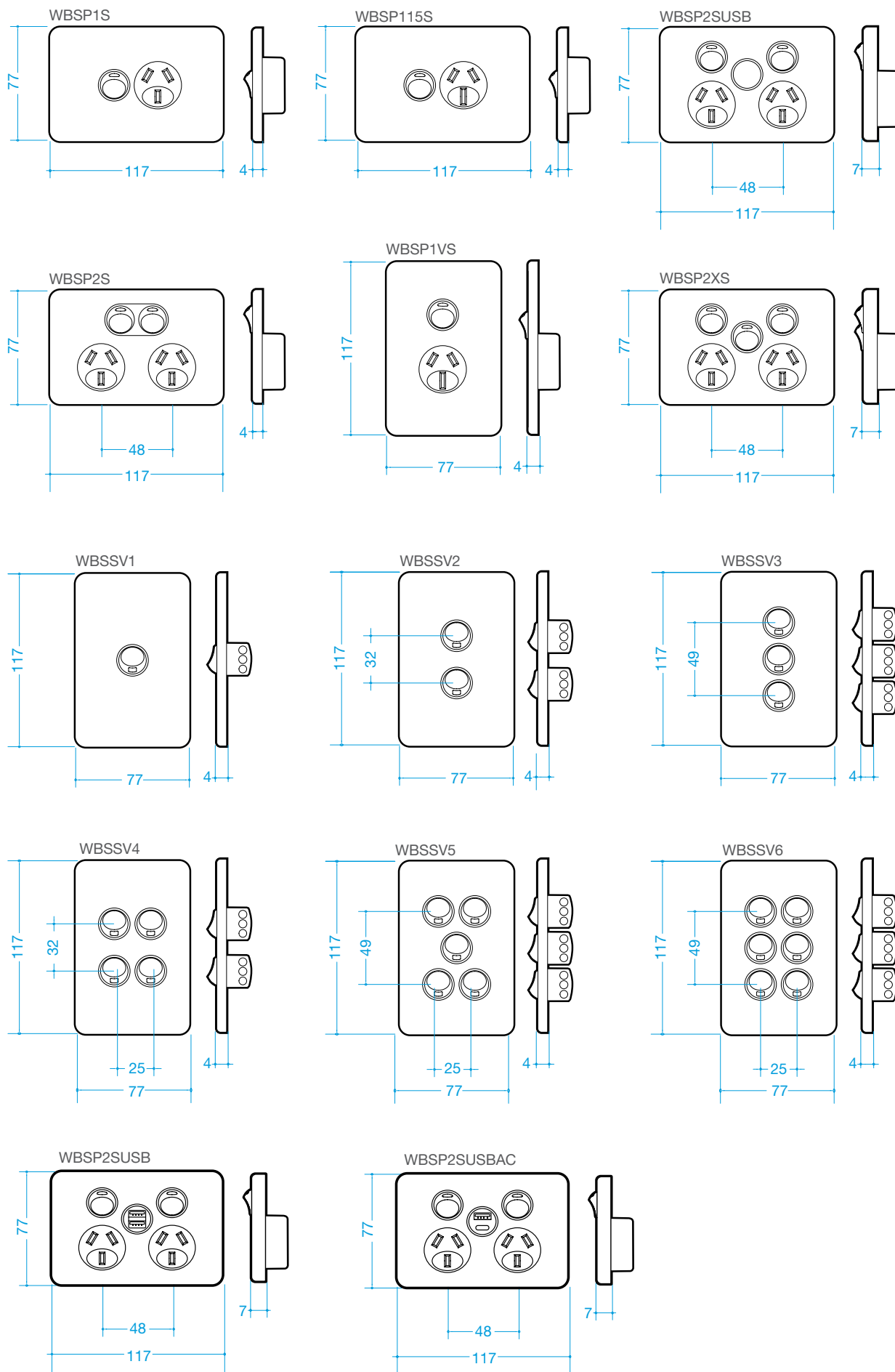

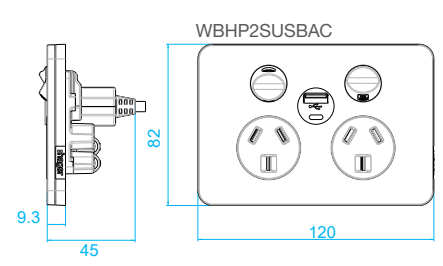
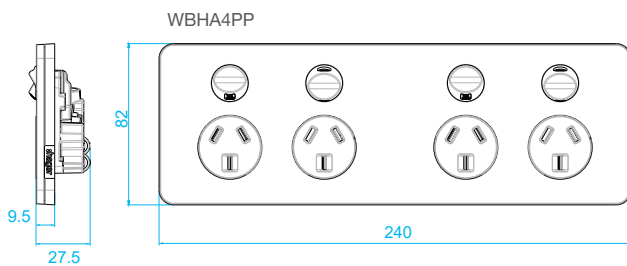
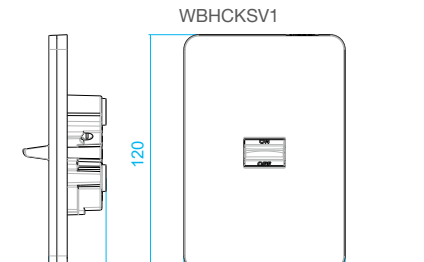
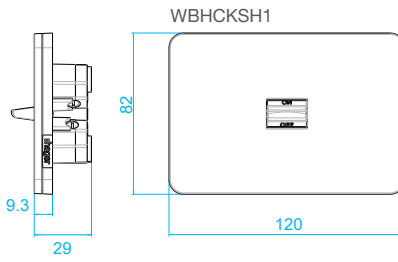
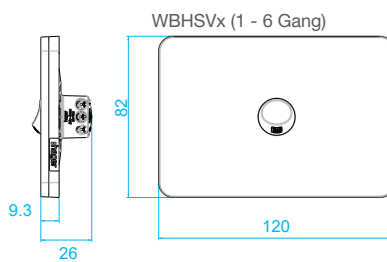
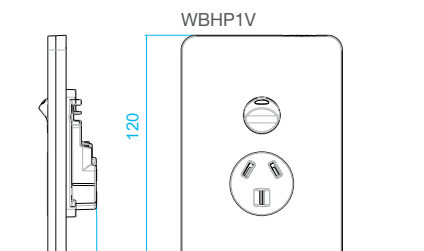
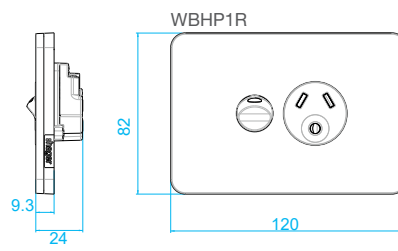
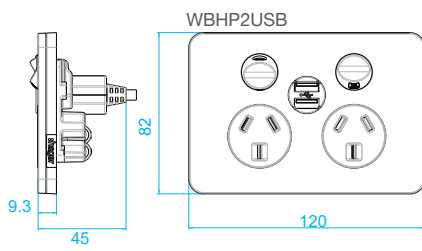
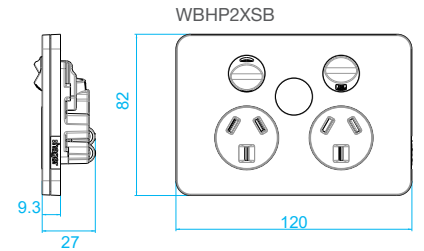
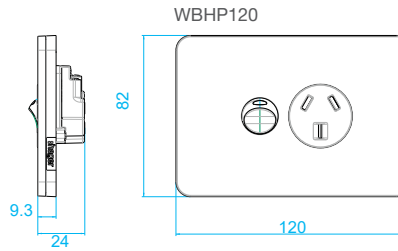
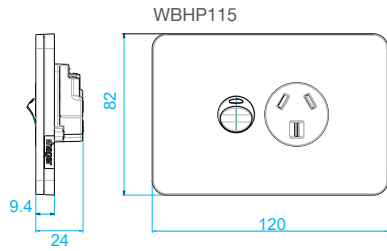
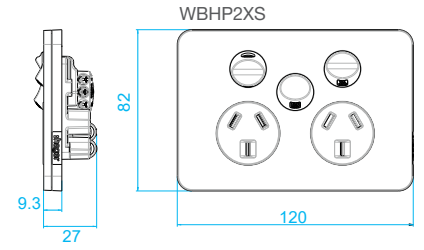
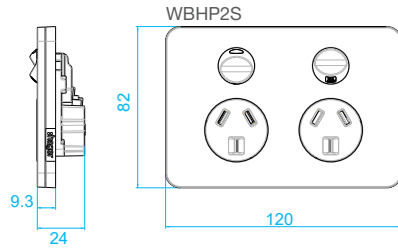
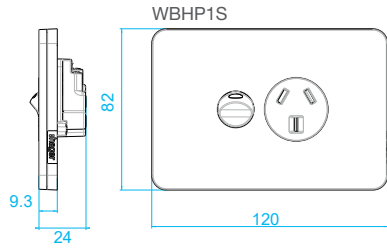

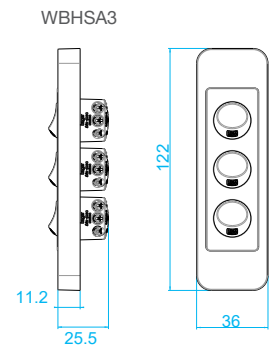
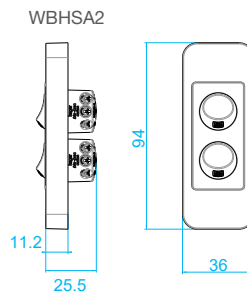
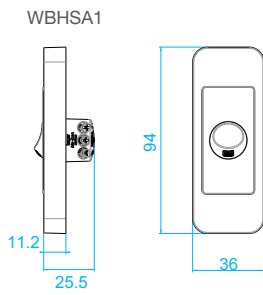
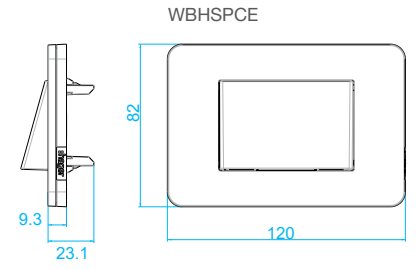
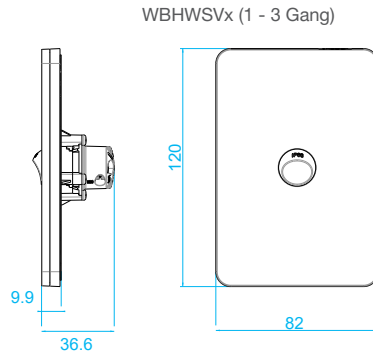
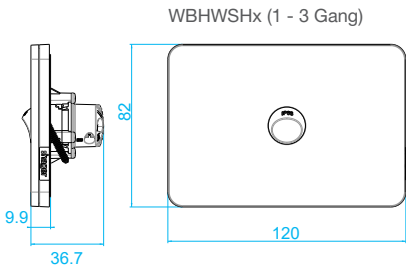
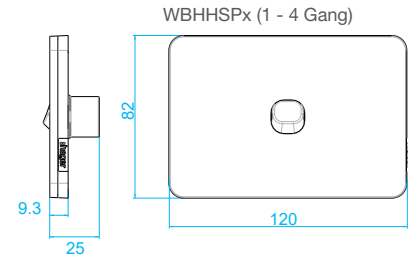
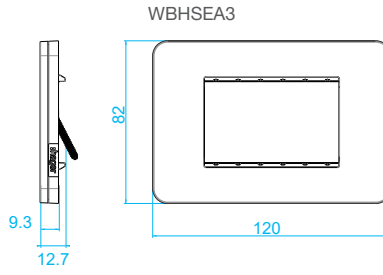
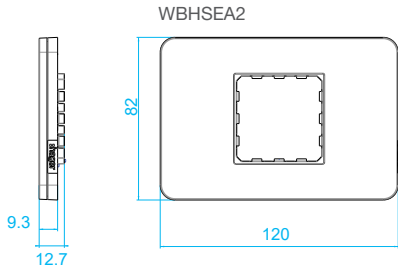

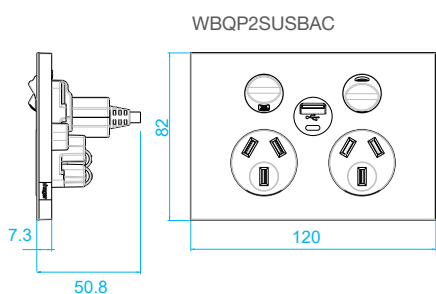
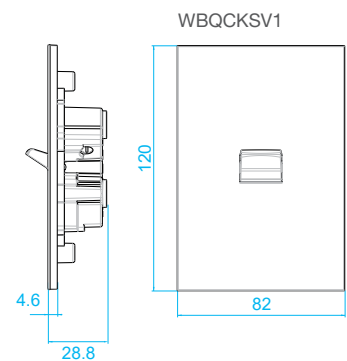
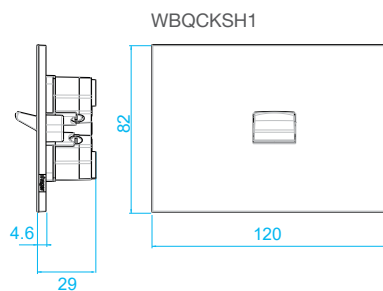
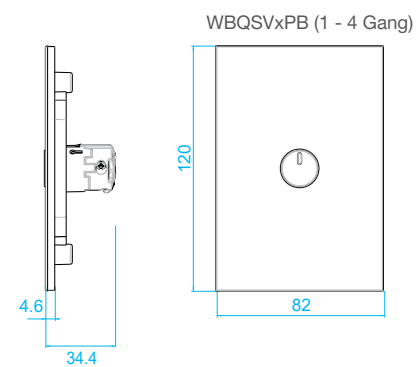
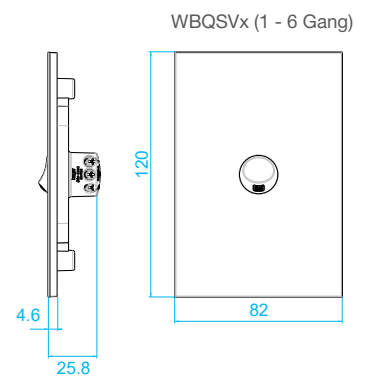
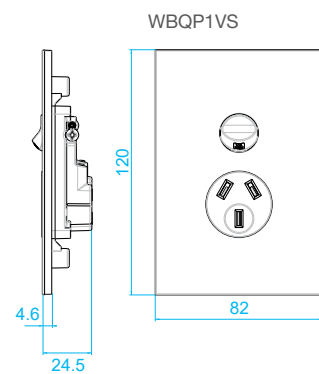
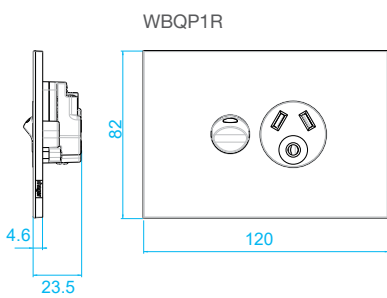
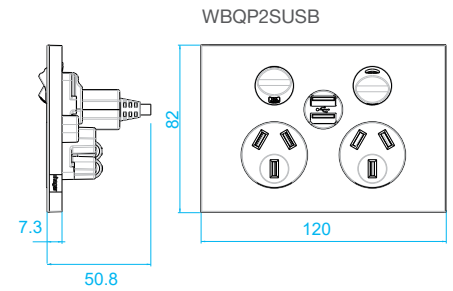
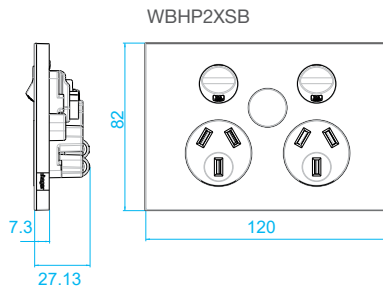
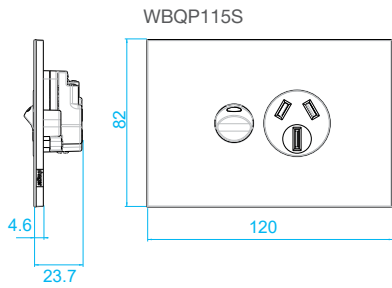
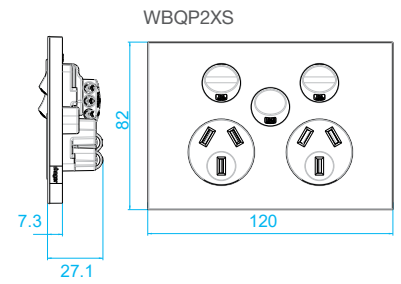
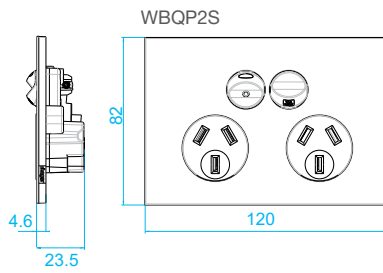
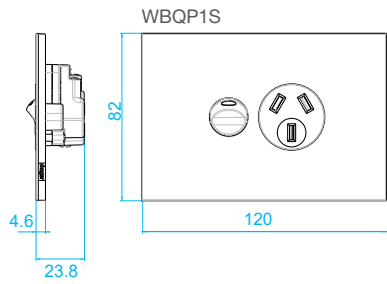

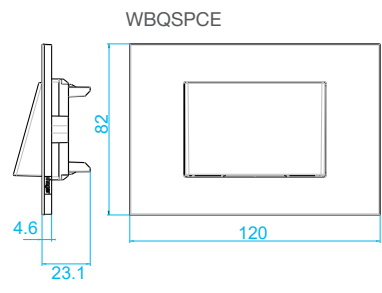
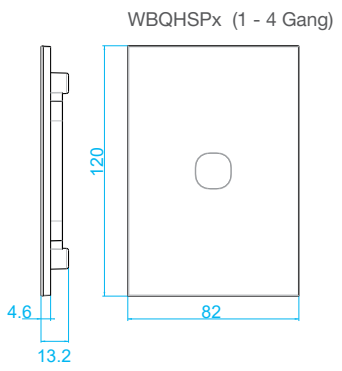
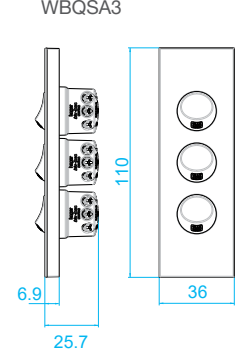
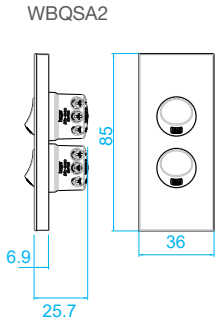
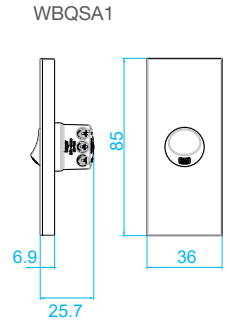
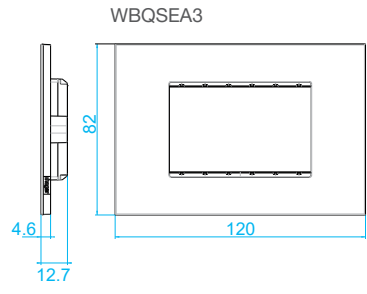
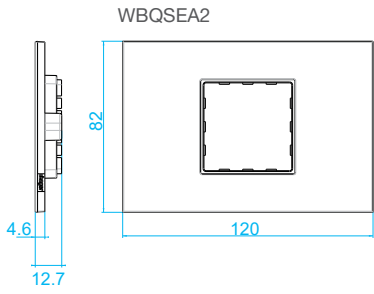

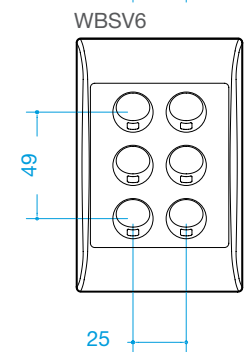
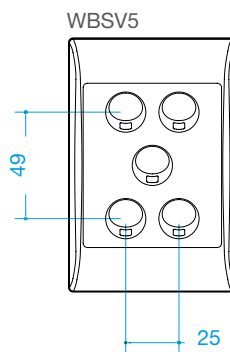
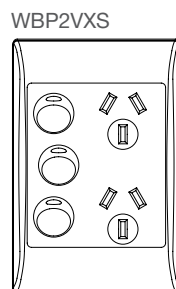
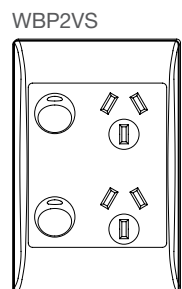
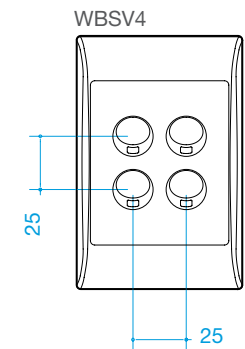
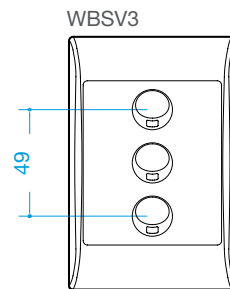
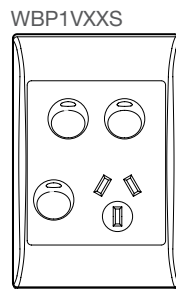
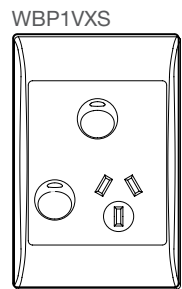
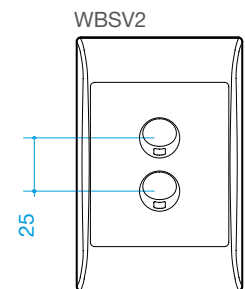
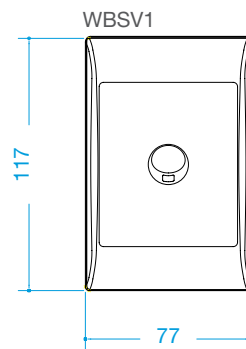
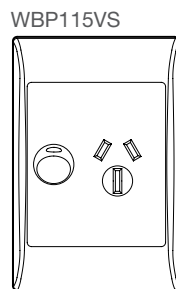
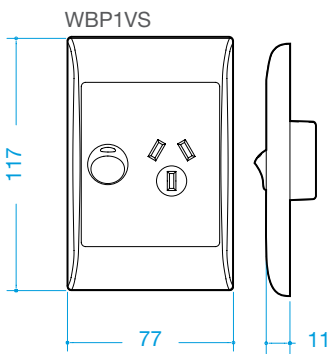
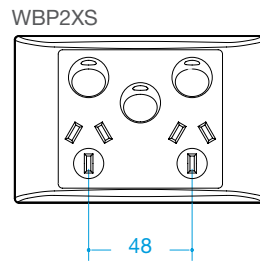
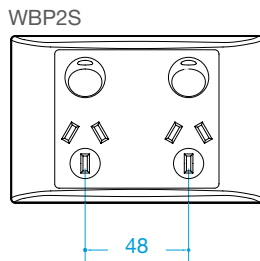
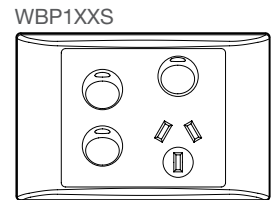
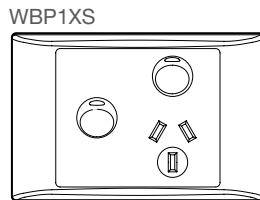
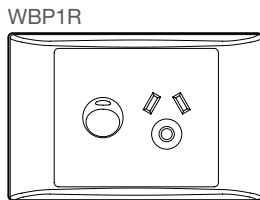
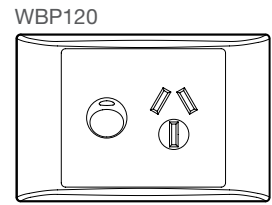
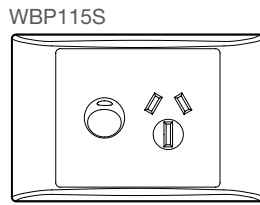
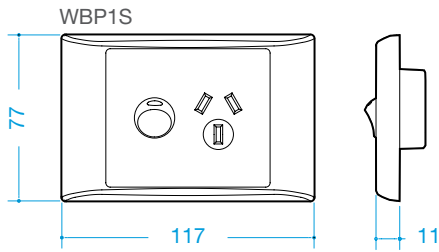

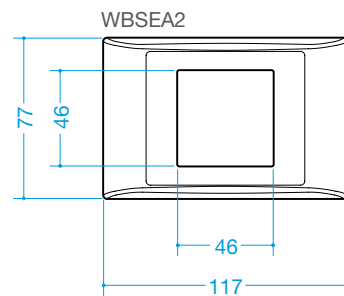
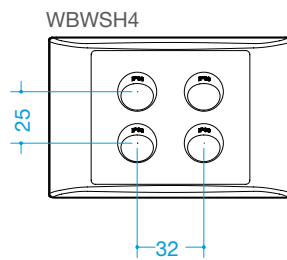
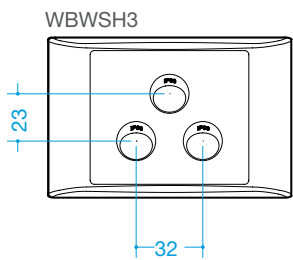
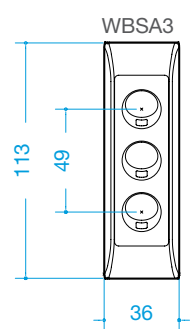
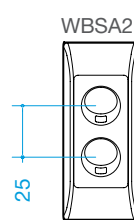
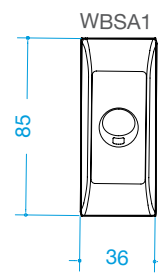
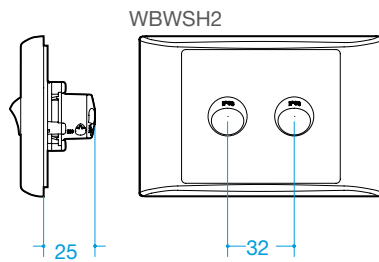
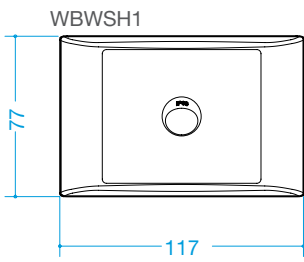
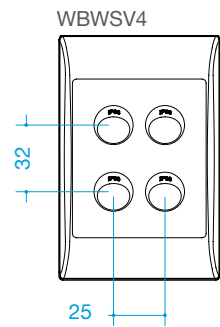
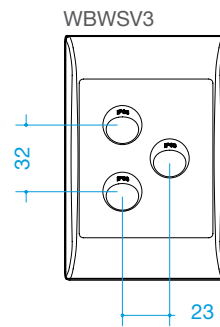
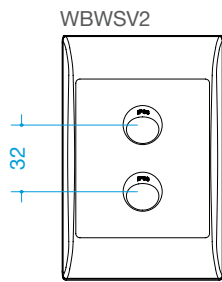
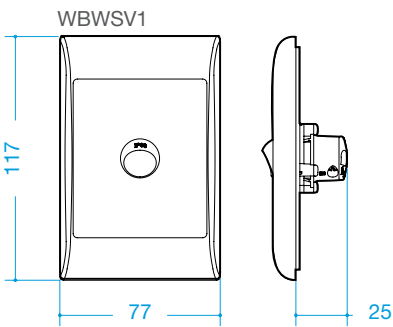
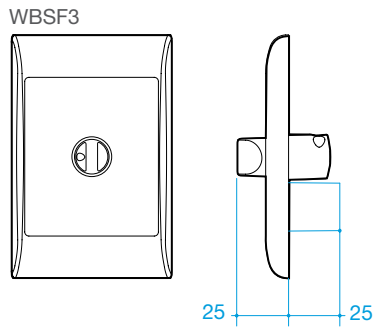
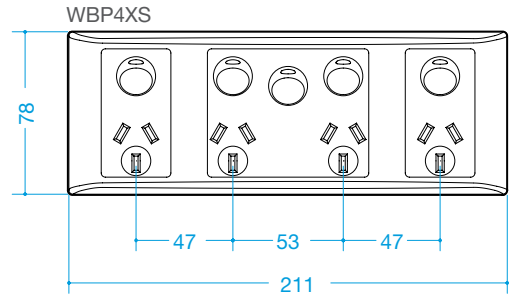
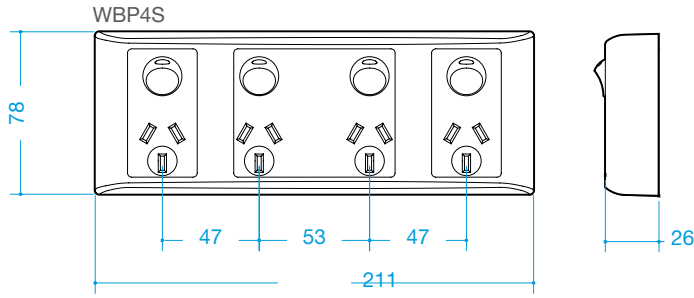

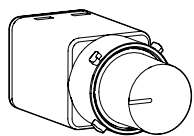

Rotary Dimmer
WBMDUR

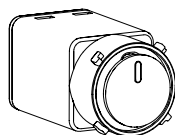

Push Button
WBMDUPB

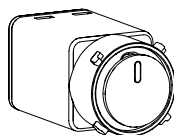

Push Button Slave
WBMSLL

Programmable to:

- Set minimum brightness
- Reduce max brightness (fixes reduction)
- Kick start
- Restore last position after power loss

Warnings:

- Derating of units is required if multi-gangging
- see table below.
- Variation in transformers can result in differing maximum numbers that can be connected to the dimmer.
- Not all LED lights are compatible with the dimmer due to many different LED brands and drivers.
Always test the compatibility with your desired LED lights before installing.

NOTE: WBMSLL slave LED indication is not based on load status. Slave LED indication can only be either permanently ON or OFF.

Wiring Diagram

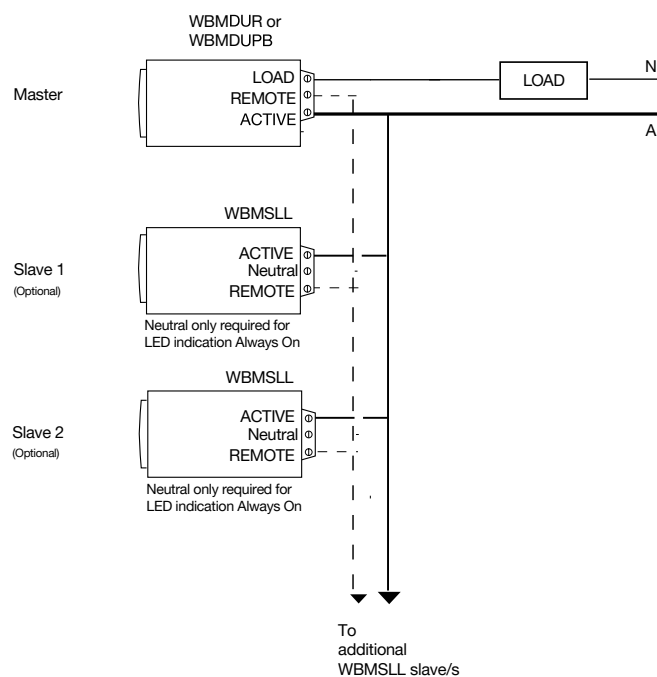

NOTE: ONLY 1 Master per load group

It is not possible to use the WBMDUR or WBMDUPB as a secondary control device or slave for the same load. (i.e. 2x WBMDUPB's cannot be wired together to control the same load).

Dimmer specification	WBMDUR / WBMDUPB/
Voltage	230V a.c. +10% / -10%
Frequency	50Hz
Operating temperature	-5 ... 50°C
Storage temperature	-20 ... 70°C
Humidity	0% .. 65% RH
IP Class	IP2X
LED Dimmable 240V	3W (min) ... 250W (max)
Max number LED lights	20 (not exceeding 250W)
Incandescent lamps	7W... 300W
Halogen with electronic Tx	20W... 350W

Dimmer specification	WBMSLL
Voltage	230V a.c. +10% / -10%
Frequency	50Hz
Operating temperature	-5 ... 50°C
Storage temperature	-20 ... 70°C
Humidity	0% .. 65% RH
IP Class	IP2X

When operating dimmers in combination with others beneath a cover plate, the maximum connected load must be reduced depending on the number of dimmers.

Number of dimmers per combination	Connect load reduction
1	100%
2	75%
3	55%
4	40%
5	35%
6	30%

WBM15P
15A Press mechanisms

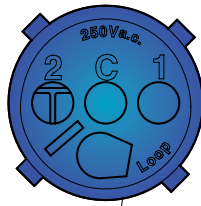
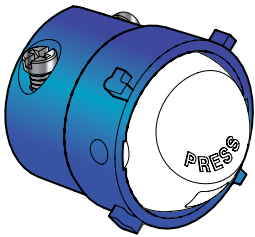

C - Common terminal
1 - N/O terminal
2 - N/C terminal
L - loop

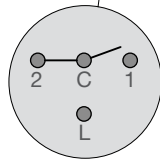

WBM10D
10A double pole mechanism

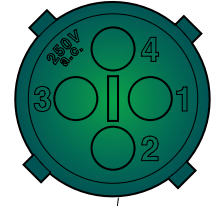
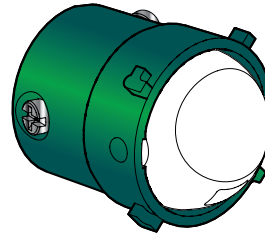

1 - Fixed terminal
3 - Fixed terminal
2 - N/O Contact
4 - N/O Contact

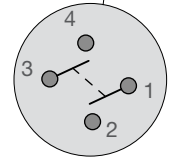

WBM10I
10A intermediate mechanism

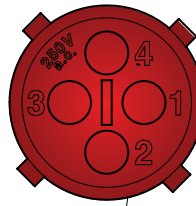
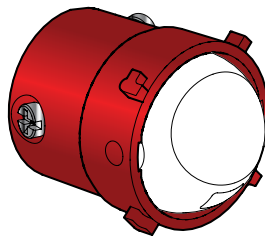

1 - Fixed terminal
3 - Fixed terminal
2 - Change over terminal
4 - Change over terminal

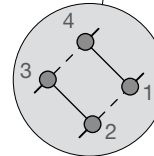

WBM16AX
16AX mechanism

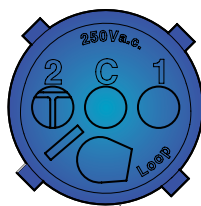
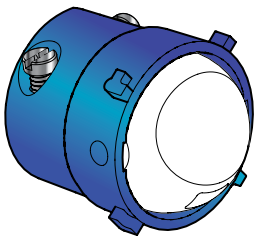

C - Common terminal
1 - N/O terminal
2 - N/C terminal
L - loop

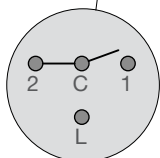

WBM20
20A mechanism

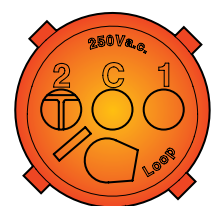
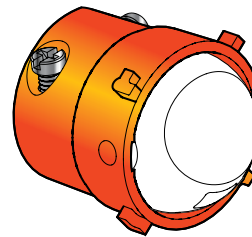

C - Common terminal
1 - N/O terminal
2 - N/C terminal
L - loop

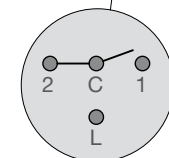

WBM20XX
Printed mechanisms
1 way only



C - Common terminal
1 - N/O terminal
L - loop



WBM20AX
20AX mechanism

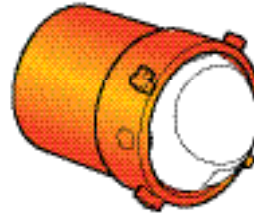

C - Common terminal
1 - N/O terminal



WBM32
32A mechanism

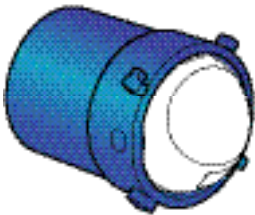

C - Common terminal
1 - N/O terminal



WBM10R3
Rotary mechanism

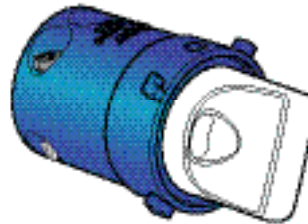

A - Common terminal
1 - load 1
2 - load 2
3 - load 3



Two Way Mechanism

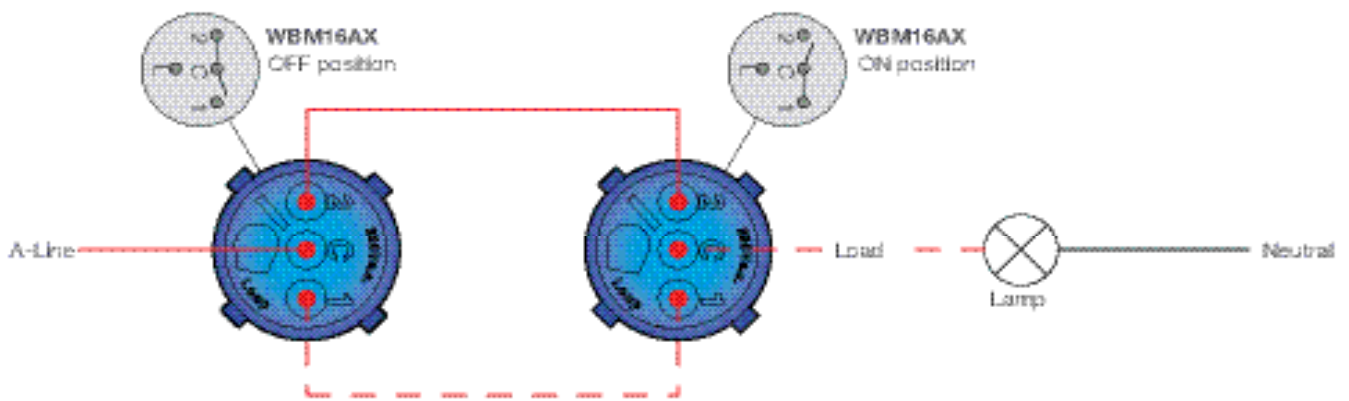
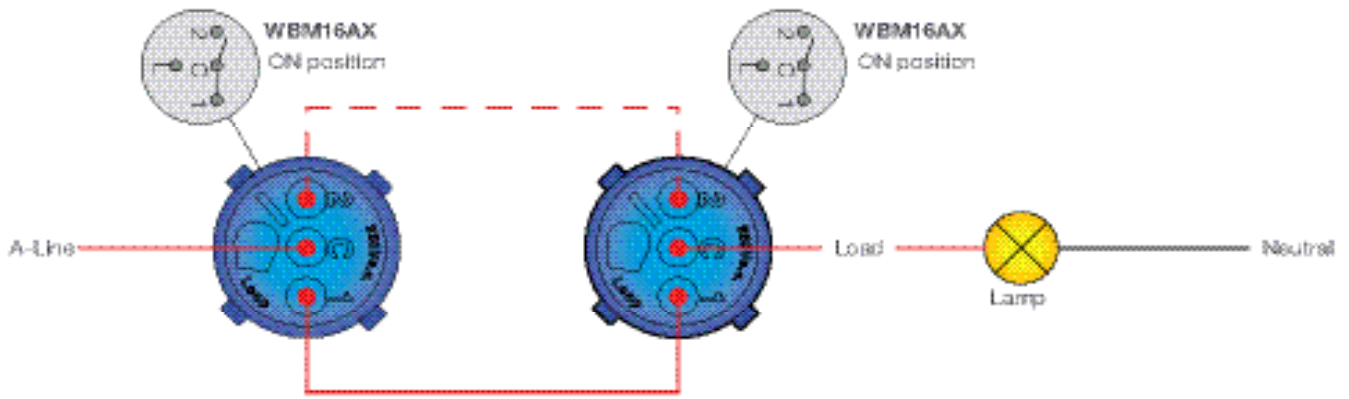

Intermediate Mechanism

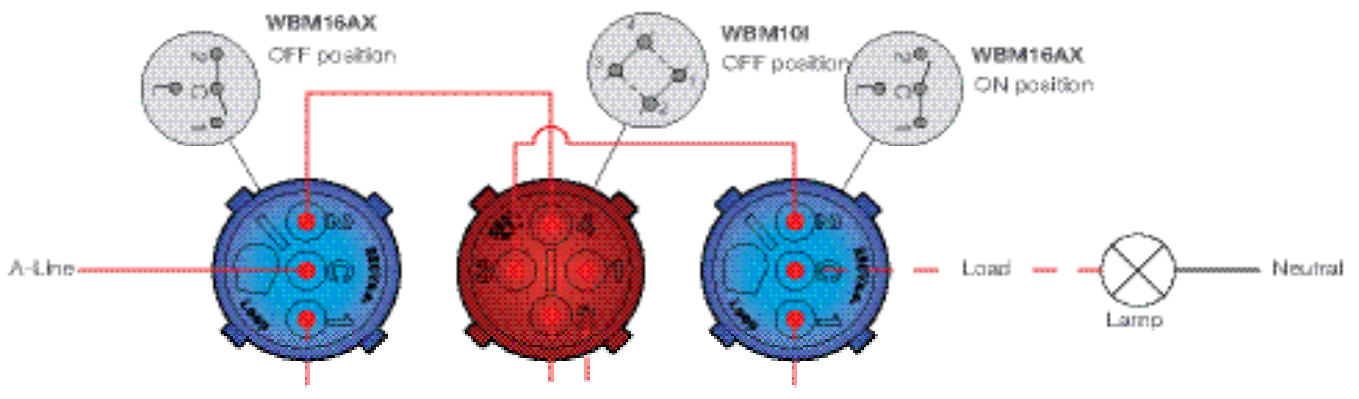
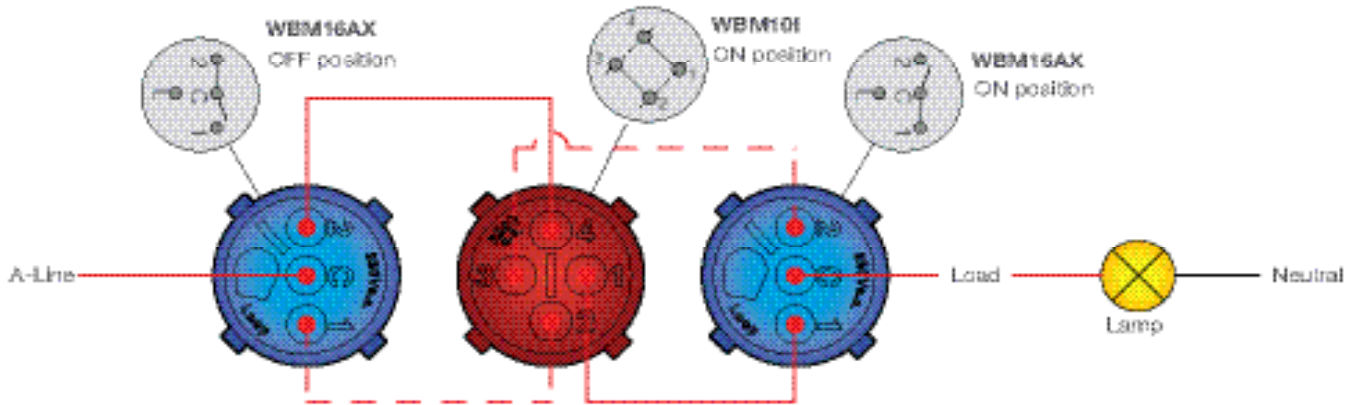

Double Pole Mechanism

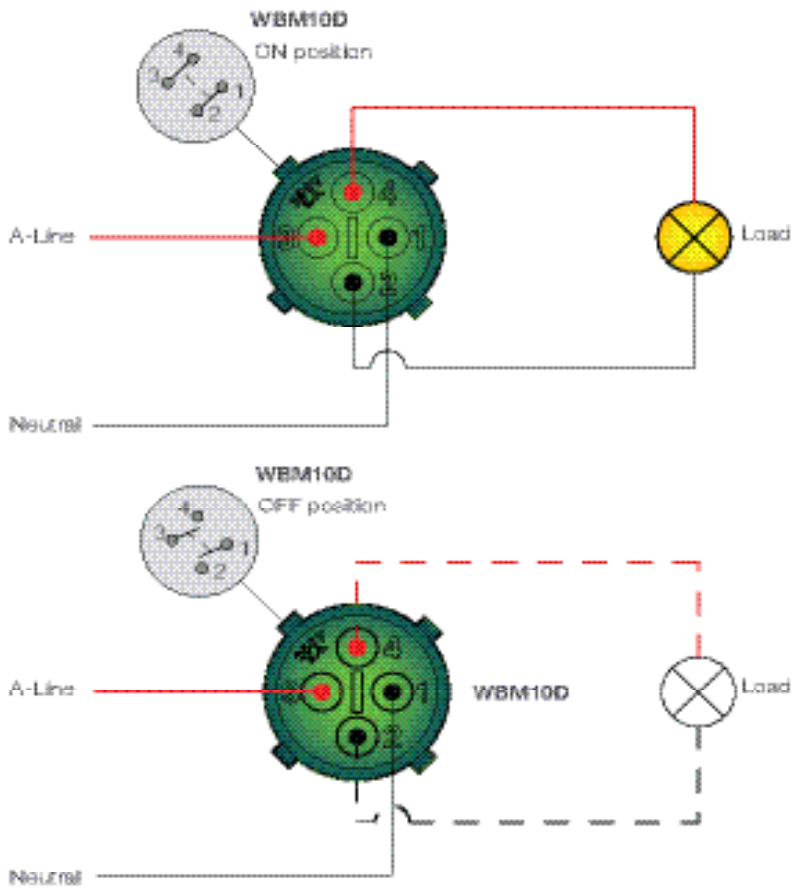

20AX Mechanism

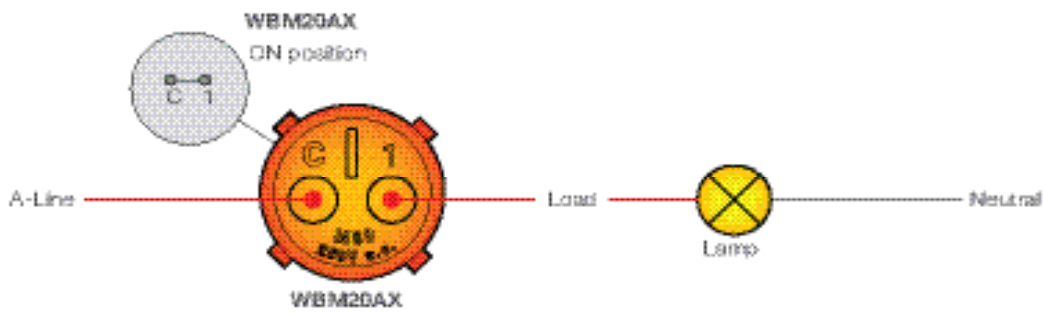

32A Mechanism

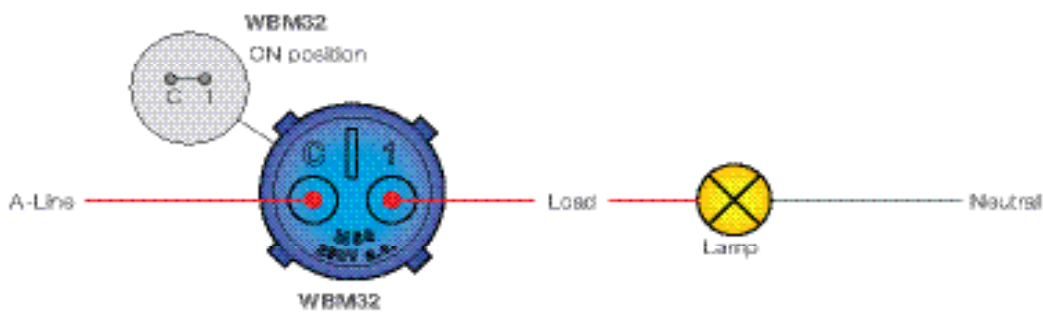

3 Position Rotary Mechanism

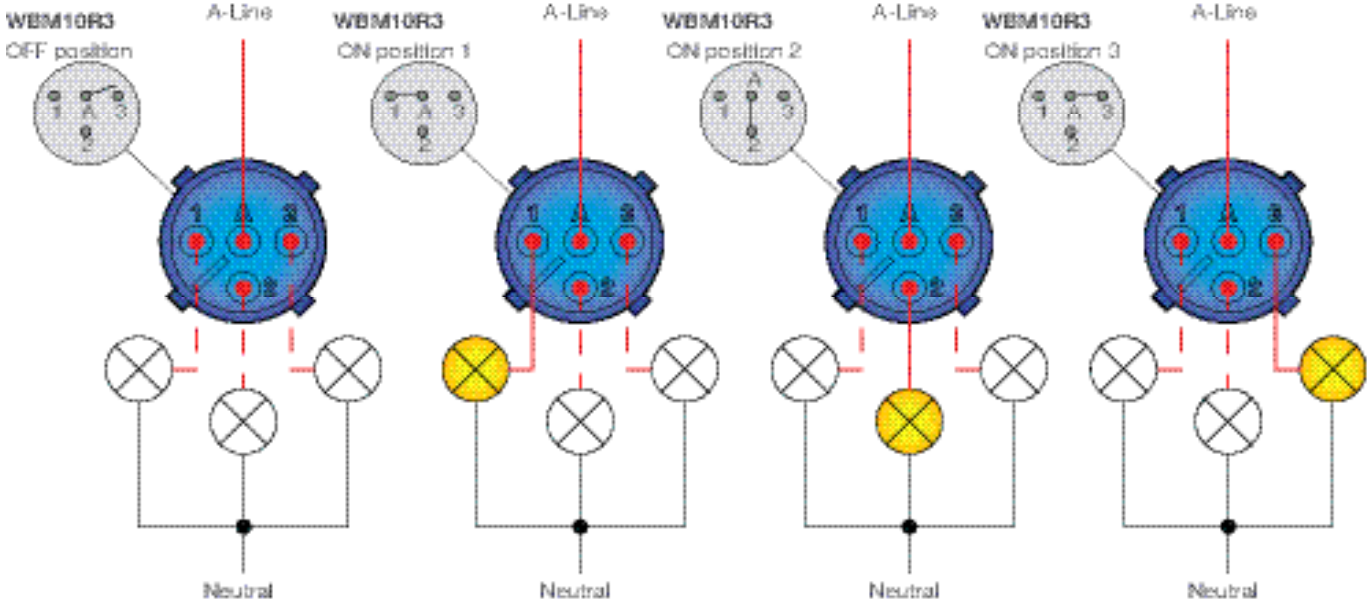

Fan Speed Control Connections for WBSF3 & WBVSF3

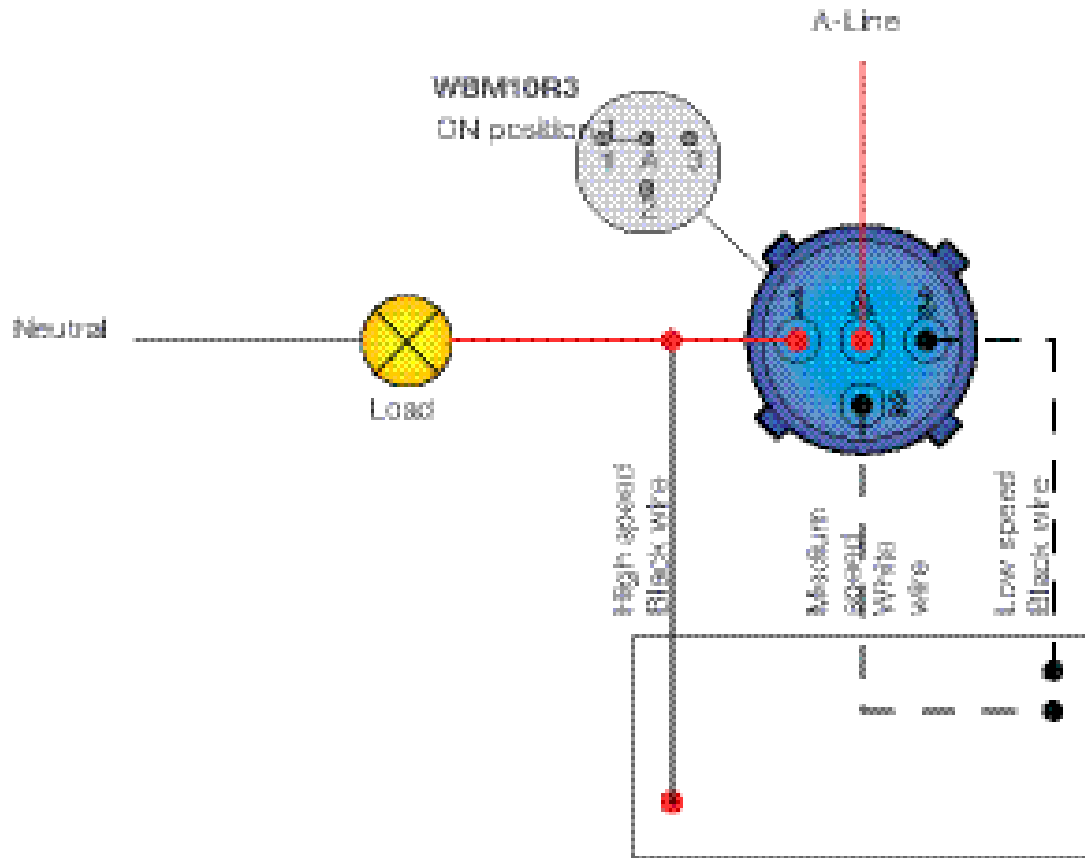

**WBMTV75PY, WBMCA1
& WBMTV75PF**

F to F, PAL to F, F to RCA mechanism

1 Strip 15mm off sheathing

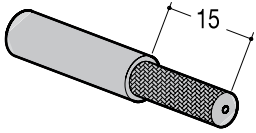

2 Fold braid, strip insulation

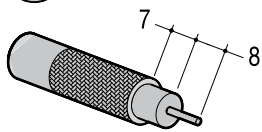

3
Crimp connector onto cable
and fit assembly to
mechanism

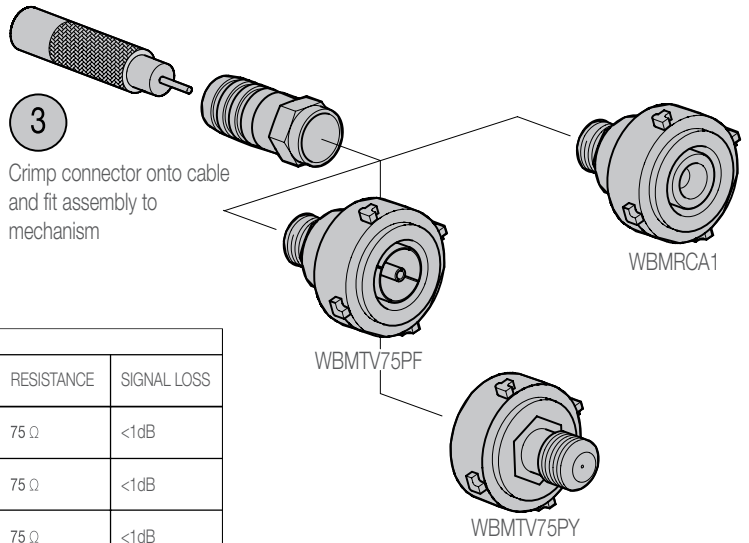

SPECIFICATIONS			
REFERENCE	TYPE CABLE	RESISTANCE	SIGNAL LOSS
WBMTV75PF	RG6 QUAD SHIELD	75 Ω	<1dB
WBMTV75PY	RG6 QUAD SHIELD	75 Ω	<1dB
WBMCA1	RG6 QUAD SHIELD	75 Ω	<1dB

WBMCAT5

Cat 5 data jack

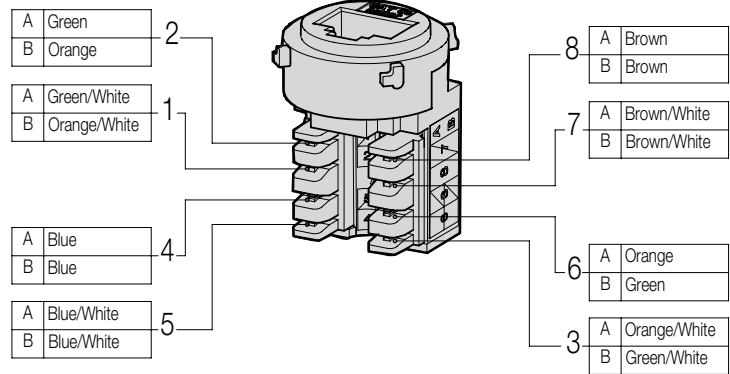
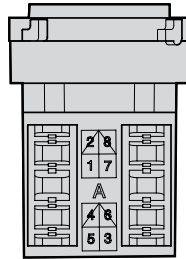
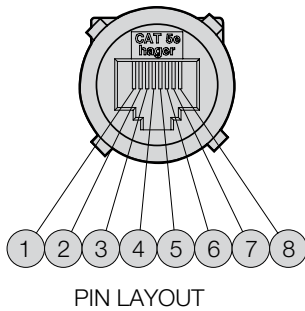

WBMCAT6

Cat 6 data jack

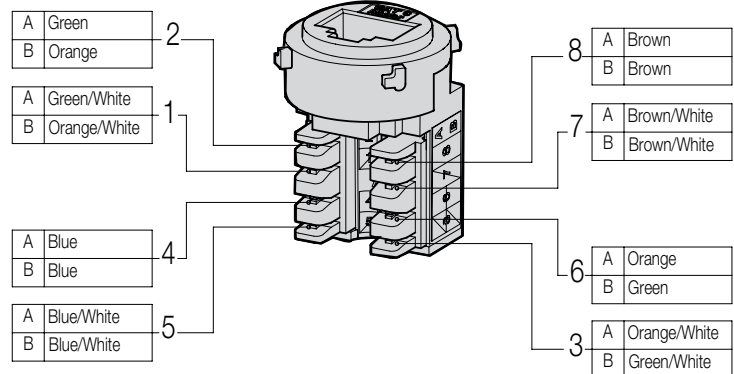
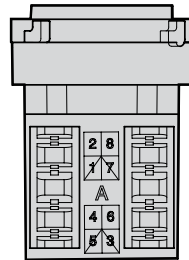
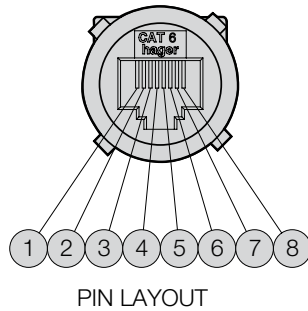

WBMCAT6A

Cat 6A data jack

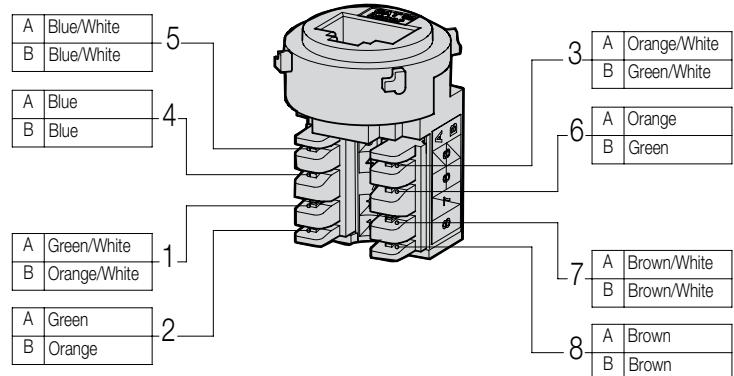
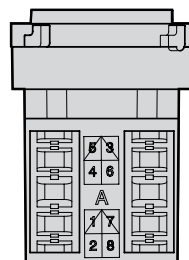
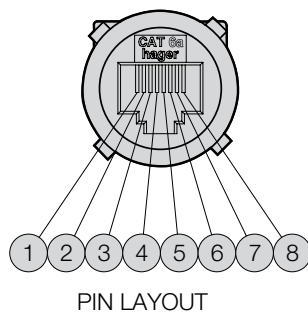

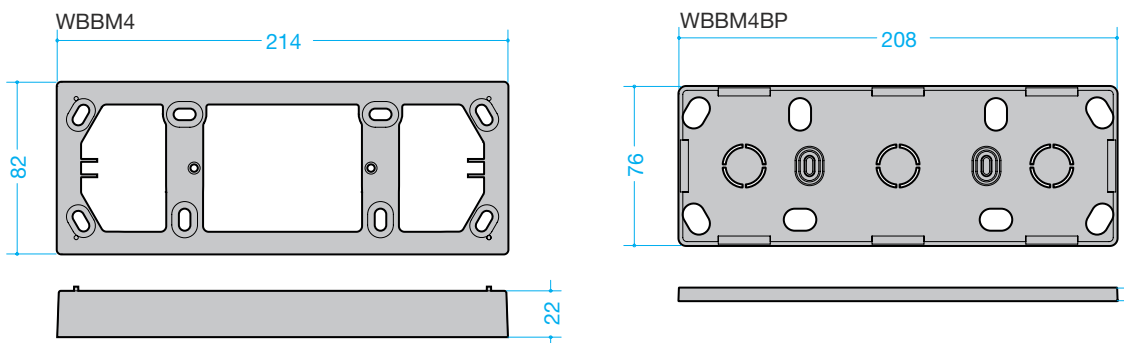
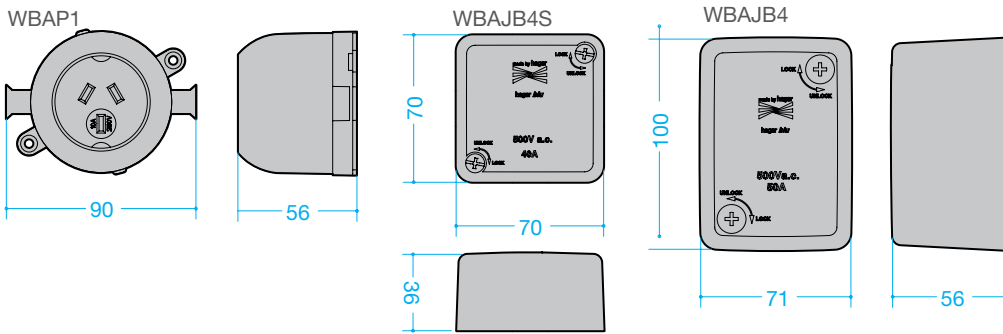
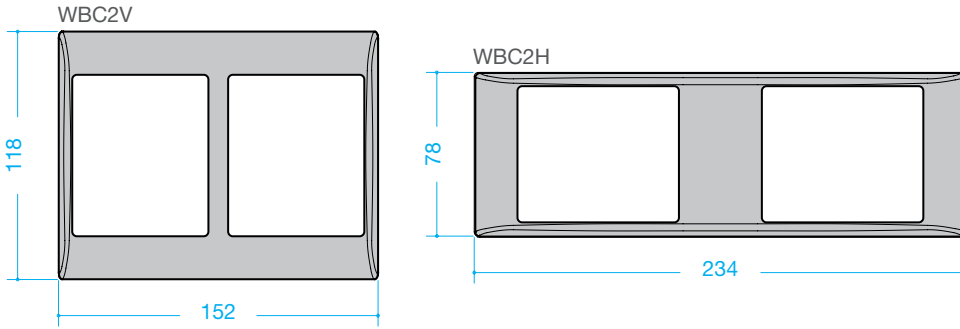
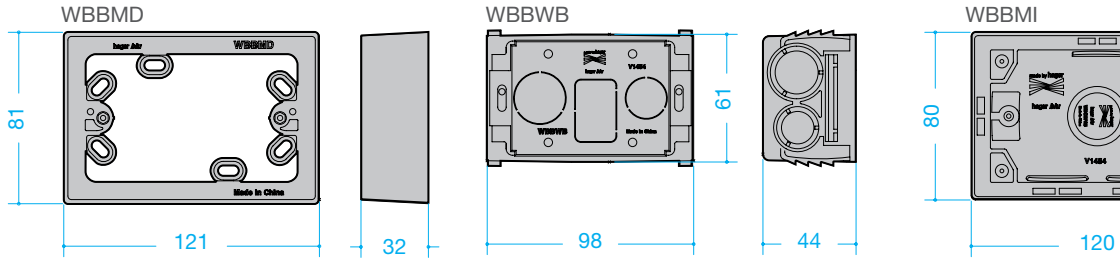

WBWP1S

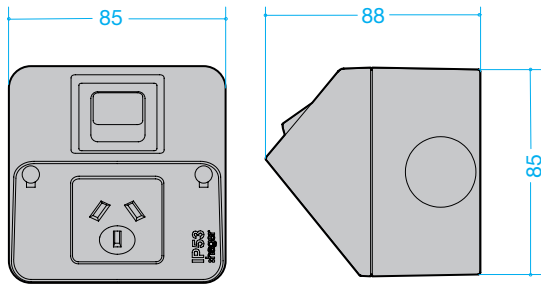

WBWP2S

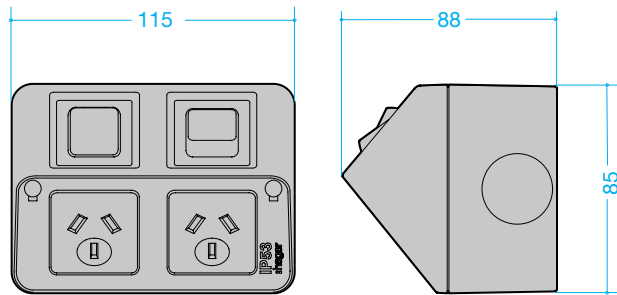

WBWP2SH

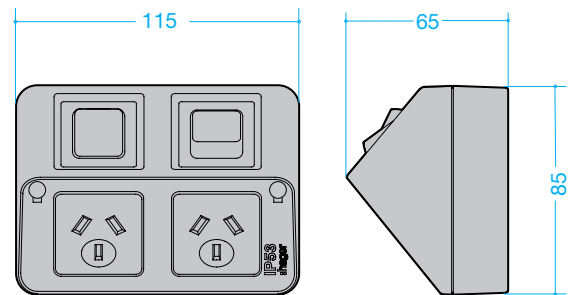

WBWS116

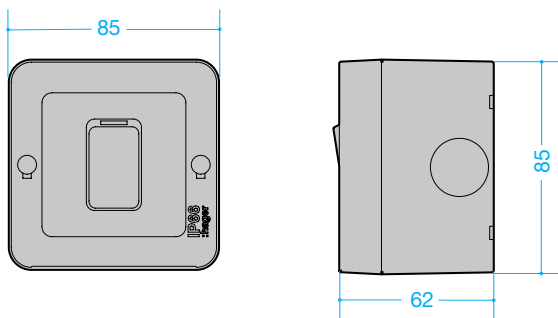

WBWS216

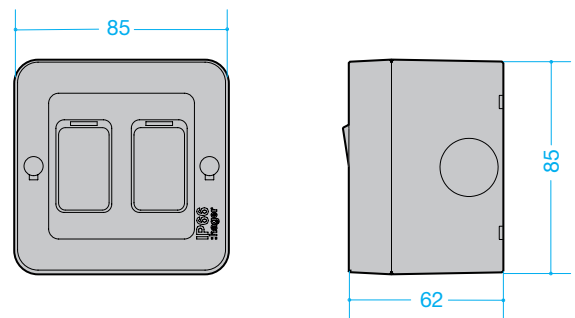

Choice of isolator switches

The switch-disconnectors are defined by:

- their ratings and voltage,
- their utilization category,
- their short circuit rating.

The choice of isolator is dependent upon many parameters:

- 01 - the number of poles,
- 02 - the type of electrical load it needs to isolate
- 03 - its consumption under normal operation

The appliances, when hard wired, shall be provided with a lockable isolation device, installed adjacent to the unit including water heaters, motors/compressors, air conditioners, heat pump systems...

01 - Number of poles

Usually this is the subject of agreement between manufacturer and user. In the wiring rules, the minimum requirement for isolation devices is to isolate all active conductors from the circuit. However manufacturers generally recommend isolating the neutral as well, for safety purposes.

02 - Type of electrical load

Loads are categorised into various AC ratings (AC21, AC-22, AC-23 etc.) and the higher the AC rating the more inductive the load becomes. AS/NZS IEC 60947.3 defines utilization categories as well as their applications:

Utilization category

Frequent operation	Occasional operation	Typical applications
AC-20A*	AC-20B*	Connecting and breaking under no-load
AC-21A	AC-21B	Switching of resistive loads including moderate overloads (e.g. electric hot water heater)
AC-22A	AC-22B	Switching of mixed resistive and inductive loads, including moderate overloads (e.g. fluorescent lamp, slip-ring/shunt motors)
AC-23A	AC-23B	Switching of highly inductive loads or motor loads (e.g. compressors, series/squirrel-cage motor loads)

* not utilised in Australia

Generally, category AC-23 includes occasional switching of individual motors and does not cover the switching of capacitors or of tungsten filament lamps.

An easy way to choose the utilization category is to check the inrush current and/or the $\cos \phi$ of the load:

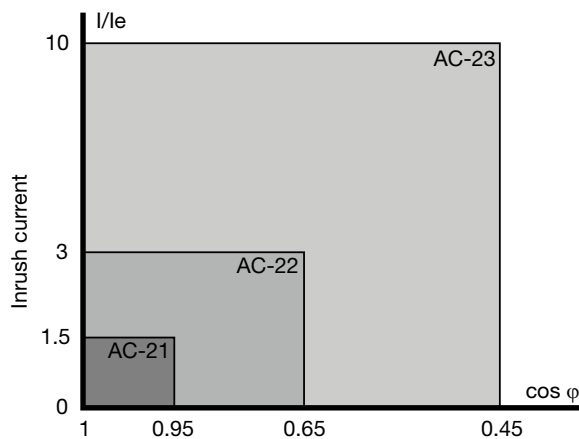

Source: Socomec UcRI

03 - Power demand

The selection of an isolating switch is reduced to the comparison of its performance data with the respective utilization category, the ratings of the load and the choice of a device which meets or exceeds the ratings of the load.

Motor/Compressor applications

The isolation of motor/compressor loads are covered under the utilization category AC-23.

Motor/compressor applications include:

- Heat pumps,
- Air-conditioning systems,
- Pumps,
- Ventilators,
- Elevators

The choice of the isolator depends on the maximum power input or the maximum load current of the appliance. As an example, the compliance plate of an air conditioner would provide the maximum power input in kW or the maximum load current in A.

AIR CONDITIONER SPLIT TYPE (OUTDOOR UNIT) MODEL AAP270G-A2			
STANDARD AS/NZS 3823.1			
PERFORMANCE (CLIMATE CLASS T1)		230/240V ~ 50Hz	
TOTAL CAPACITY	COOLING HEATING	2.0 2.7	kW kW
TOTAL INPUT	COOLING HEATING	0.44 0.62	kW kW
TOTAL CURRENT	COOLING HEATING	2.4/2.3 3.1/3.0	A A
MAX. INPUT		1.65	kW
MAX. CURRENT		9	A
MAX. HIGH PRESSURE		4.15	MPa
MAX. LOW PRESSURE		1.60	MPa

The difficulty with all motor/compressor loads are the high inrush currents which can amount to 5-10 times the nominal current. Also, inductive loads tend to build electric arcs during shut off. Therefore, all Hager IP66 Isolator switch ratings are given at utilization category AC-23A without de-rating.

Resistive-type applications

The current demand of a heating appliance or an incandescent lamp is easily obtained from the nominal power quoted by the manufacturer (i.e. $1 > \cos \phi > 0.95$)

The currents are given by:

- 3-phase case: $I_e = P_n \div (\sqrt{3} \times U)$

- 1-phase case: $I_e = P_n \div U$

Where I_e is amps; U is volts, voltage between the terminals of the equipment; P_n is watts. If P_n is in kW, then multiply the equation by 1,000

Specifications to AS/NZS IEC60947-3 / IP66

Reference	JG220IN	JG232IN	JG240IN	JG263IN	JG320IN	JG332IN	JG340IN	JG420IN	JG432IN	JG440IN	JG463IN
Number of poles	2P	2P	2P	2P	3P	3P	3P	4P	4P	4P	4P
Operational frequency	50/60Hz	50/60Hz	50/60Hz	50/60Hz	50/60Hz	50/60Hz	50/60Hz	50/60Hz	50/60Hz	50/60Hz	50/60Hz
Rated operational voltage Ue	250V AC	250V AC	250V AC	250V AC	440V AC	440V AC	440V AC	440V AC	440V AC	440V AC	440V AC
Rated insulation voltage Ui (AC)	440V	440V	440V	440V	440V	440V	440V	440V	440V	440V	440V
Rated impulse withstand voltage Uimp	4000V	4000V	4000V	4000V	4000V	4000V	4000V	4000V	4000V	4000V	4000V

Rated operational current and power ratings in AC

Rated operational current Ie	20A	32A	40A	63A	20A	32A	40A	20A	32A	40A	63A	
Rated operational power Pe	AC-21A	4.8kW	7.6kW	9.5kW	15kW	14.5kW	23.2kW	29kW	14.5kW	23.2kW	29kW	45.6kW
	AC-22A	4.0kW	6.4kW	8.0kW	12.6kW	12.2kW	19.5kW	24.4kW	12.2kW	19.5kW	24.4kW	38.4kW
	AC-23A	3.2kW	5.2kW	6.5kW	10.2kW	9.9kW	15.8kW	19.8kW	9.9kW	15.8kW	19.8kW	31.2kW

Short circuit characteristics

Rated short-time withstand current for 1 sec Icw	240A	384A	480A	756A	240A	384A	480A	240A	384A	480A	756A
Rated short-circuit capacity Icm	240A	384A	480A	756A	240A	384A	480A	240A	384A	480A	756A

Mechanical characteristics



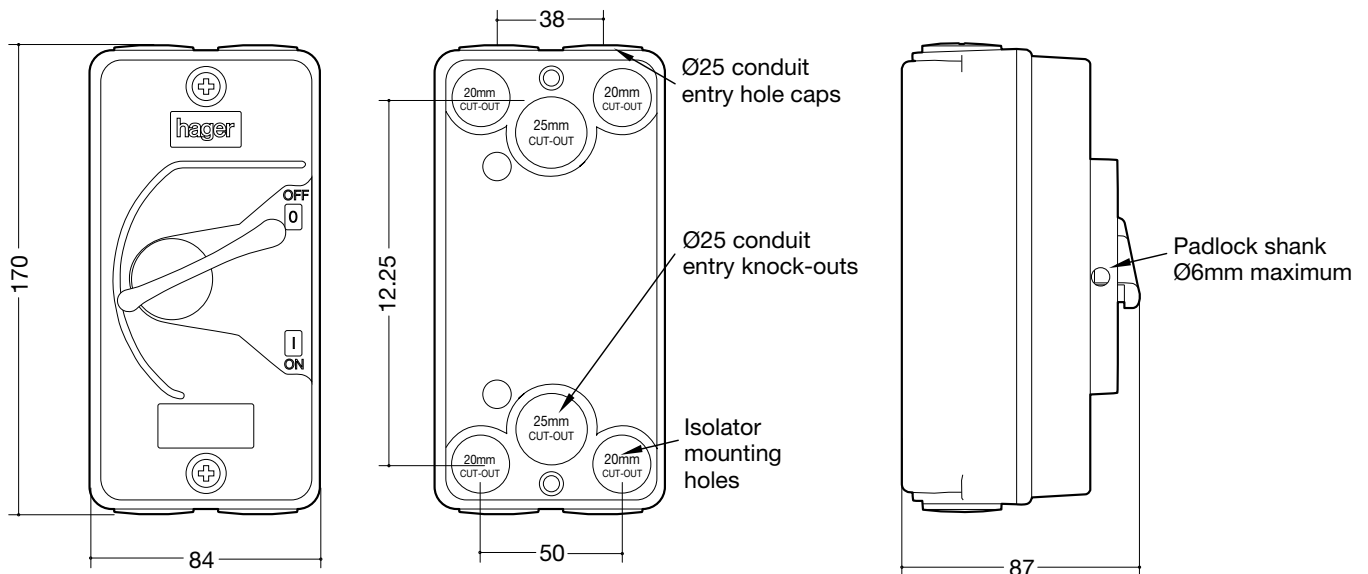

Conductor Rigid - stranded	Min. size & number	2.5mm ²	6mm ²	6mm ²	10mm ²	2.5mm ²	6mm ²	6mm ²	2.5mm ²	6mm ²	6mm ²	10mm ²
		Max. size	1	1	1	1	1	1	1	1	1	1

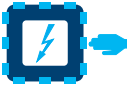

The IP rating for all low voltage enclosures up to 1000 V a.c. and 1500 V d.c. is defined in identical fashion by the standards EN 60529 - IEC 529. It comprises the letters IP followed by two character numerals and or additional/ supplementary letters.

The first character numeral indicates the degree of protection provided by the enclosure against access to hazardous parts by preventing or limiting the ingress of a part of the human body or an object held by a person and ingress of solid foreign objects.

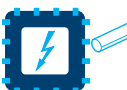
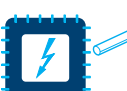
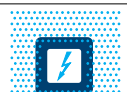
The first character numeral:
Protection against foreign objects

IP	Description	
0		Non-protected
1		Protected against solid objects \geq than 50mm
2		Protected against solid objects \geq than 12.5mm
3		Protected against solid objects \geq than 2.5mm
4		Protected against solid objects \geq than 1.0mm
5		Dust-protected
6		Dust-tight









Additional letter (in option)

Protection of people against access to hazardous parts

	Description
A	Protected against access to hazardous parts with the back of the hand
B	Protected against access to hazardous parts with a finger
C	Protected against access to hazardous parts with a tool - \varnothing 2.5mm
D	Protected against access to hazardous parts with a wire - \varnothing 1mm

The second character numeral indicates the degree of protection provided by the enclosure with respect to harmful effects on the equipment due to the ingress of water. An X signifies that the tests are not applicable to the product.

The second character numeral:
Protection against ingress of water with harmful effects

IP	Description	
0		Non-protected
1		Protected against vertically falling water drops
2		Protected against vertically falling water drops when enclosure tilted up to 15°
3		Protected against spraying water
4		Protected against splashing water
5		Protected against water jets
6		Protected against powerful water jets
7		Protected against the effect of temporary immersion in water
8		Protected against continuous immersion in water

Additional letter (in option)

Specific information on the product

	Description
H	High voltage apparatus
M	Motion during water test
S	Stationary during water test
W	Weather conditions